

CCSDS Historical Document

This document's Historical status indicates that it is no longer current. It has either been replaced by a newer issue or withdrawn because it was deemed obsolete. Current CCSDS publications are maintained at the following location:

<http://public.ccsds.org/publications/>



Recommendations for Space Data System Standards

RADIO FREQUENCY AND MODULATION SYSTEMS— PART 1 EARTH STATIONS AND SPACECRAFT

RECOMMENDED STANDARD

CCSDS 401.0-B

BLUE BOOK
July 2008



Recommendations for Space Data System Standards

**RADIO FREQUENCY AND
MODULATION SYSTEMS—
PART 1
EARTH STATIONS AND SPACECRAFT**

RECOMMENDED STANDARD

CCSDS 401.0-B

BLUE BOOK
July 2008

Earth Stations and Spacecraft

AUTHORITY

Issue:	Recommended Standard, Issue 19
Date:	July 2008
Location:	Washington, DC, USA

This document has been approved for publication by the Management Council of the Consultative Committee for Space Data Systems (CCSDS) and represents the consensus technical agreement of the participating CCSDS Member Agencies. The procedure for review and authorization of CCSDS Recommendations is detailed in the reference [1], and the record of Agency participation in the authorization of this document can be obtained from the CCSDS Secretariat at the address below.

This document is published and maintained by:

CCSDS Secretariat
Space Communications and Navigation Office, 7L70
Space Operations Mission Directorate
NASA Headquarters
Washington, DC 20546-0001, USA

Earth Stations and Spacecraft

STATEMENT OF INTENT

The Consultative Committee for Space Data Systems (CCSDS) is an organization officially established by the management of its members. The Committee meets periodically to address data systems problems that are common to all participants, and to formulate sound technical solutions to these problems. Inasmuch as participation in the CCSDS is completely voluntary, the results of Committee actions are termed **Recommended Standards** and are not considered binding on any Agency.

This **Recommended Standard** is issued by, and represents the consensus of, the CCSDS members. Endorsement of this **Recommendation** is entirely voluntary. Endorsement, however, indicates the following understandings:

- o Whenever a member establishes a CCSDS-related **standard**, this **standard** will be in accord with the relevant **Recommended Standard**. Establishing such a **standard** does not preclude other provisions which a member may develop.
- o Whenever a member establishes a CCSDS-related **standard**, that member will provide other CCSDS members with the following information:
 - The **standard** itself.
 - The anticipated date of initial operational capability.
 - The anticipated duration of operational service.
- o Specific service arrangements shall be made via memoranda of agreement. Neither this **Recommended Standard** nor any ensuing **standard** is a substitute for a memorandum of agreement.

No later than five years from its date of issuance, this **Recommended Standard** will be reviewed by the CCSDS to determine whether it should: (1) remain in effect without change; (2) be changed to reflect the impact of new technologies, new requirements, or new directions; or (3) be retired or canceled.

In those instances when a new version of a **Recommended Standard** is issued, existing CCSDS-related member standards and implementations are not negated or deemed to be non-CCSDS compatible. It is the responsibility of each member to determine when such standards or implementations are to be modified. Each member is, however, strongly encouraged to direct planning for its new standards and implementations towards the later version of the Recommended Standard.

Earth Stations and Spacecraft

FOREWORD

This document, which is a set of technical Recommendations prepared by the Consultative Committee for Space Data Systems (CCSDS), is intended for use by participating space Agencies in their development of Radio Frequency and Modulation systems for Earth stations and spacecraft.

These Recommendations allow implementing organizations within each Agency to proceed coherently with the development of compatible Standards for the flight and ground systems that are within their cognizance. Agency Standards derived from these Recommendations may implement only a subset of the optional features allowed by the Recommendations herein, or may incorporate features not addressed by the Recommendations.

In order to establish a common framework within which the Agencies may develop standardized communications services, the CCSDS advocates adoption of a layered systems architecture. These Recommendations pertain to the physical layer of the data system. Within the physical layer, there are additional layers covering the technical characteristics, policy constraints, and procedural elements relating to communications services provided by radio frequency and modulation systems. Recommendations contained in this document have been grouped into separate sections representing technical, policy, and procedural matters.

These Recommendations for Radio Frequency and Modulation Systems, Part 1: Earth Stations and Spacecraft, were developed for conventional near-Earth and deep-space missions having moderate communications requirements. Part 2 will be concerned with data relay satellites and will address the needs of users requiring services not provided by the Earth stations covered in this document.

The CCSDS will continue to develop Recommendations for Part 1: Earth Stations and Spacecraft, to ensure that new technology and the present operating environment are reflected. New Recommendations for Part 1, which are developed in the future, will utilize the same format and be designed to be inserted into this book. Holders of this document should make periodic inquiry of the CCSDS Secretariat, at the address on page i, to make sure that their book is fully current.

Through the process of normal evolution, it is expected that expansion, deletion, or modification to individual Recommendations in this document may occur. This document is therefore subject to CCSDS document management and change control procedures which are defined in reference [1]. Current versions of CCSDS documents are maintained at the CCSDS Web site:

<http://www.ccsds.org/>

Questions relating to the contents or status of this document should be addressed to the CCSDS Secretariat at the address indicated on page i.

Earth Stations and Spacecraft

At time of publication, the active Member and Observer Agencies of the CCSDS were:

Member Agencies

- Agenzia Spaziale Italiana (ASI)/Italy.
- British National Space Centre (BNSC)/United Kingdom.
- Canadian Space Agency (CSA)/Canada.
- Centre National d'Etudes Spatiales (CNES)/France.
- China National Space Administration (CNSA)/People's Republic of China.
- Deutsches Zentrum für Luft- und Raumfahrt e.V. (DLR)/Germany.
- European Space Agency (ESA)/Europe.
- Federal Space Agency (FSA)/Russian Federation.
- Instituto Nacional de Pesquisas Espaciais (INPE)/Brazil.
- Japan Aerospace Exploration Agency (JAXA)/Japan.
- National Aeronautics and Space Administration (NASA)/USA.

Observer Agencies

- Austrian Space Agency (ASA)/Austria.
- Belgian Federal Science Policy Office (BFSPPO)/Belgium.
- Central Research Institute of Machine Building (TsNIIMash)/Russian Federation.
- Centro Tecnico Aeroespacial (CTA)/Brazil.
- Chinese Academy of Sciences (CAS)/China.
- Chinese Academy of Space Technology (CAST)/China.
- Commonwealth Scientific and Industrial Research Organization (CSIRO)/Australia.
- Danish National Space Center (DNSC)/Denmark.
- European Organization for the Exploitation of Meteorological Satellites (EUMETSAT)/Europe.
- European Telecommunications Satellite Organization (EUTELSAT)/Europe.
- Hellenic National Space Committee (HNSC)/Greece.
- Indian Space Research Organization (ISRO)/India.
- Institute of Space Research (IKI)/Russian Federation.
- KFKI Research Institute for Particle & Nuclear Physics (KFKI)/Hungary.
- Korea Aerospace Research Institute (KARI)/Korea.
- MIKOMTEK: CSIR (CSIR)/Republic of South Africa.
- Ministry of Communications (MOC)/Israel.
- National Institute of Information and Communications Technology (NICT)/Japan.
- National Oceanic and Atmospheric Administration (NOAA)/USA.
- National Space Organization (NSPO)/Chinese Taipei.
- Naval Center for Space Technology (NCST)/USA.
- Space and Upper Atmosphere Research Commission (SUPARCO)/Pakistan.
- Swedish Space Corporation (SSC)/Sweden.
- United States Geological Survey (USGS)/USA.

CCSDS HISTORICAL DOCUMENT
CCSDS RECOMMENDATIONS FOR RADIO FREQUENCY AND MODULATION SYSTEMS

Earth Stations and Spacecraft

DOCUMENT CONTROL

DOCUMENT	TITLE	DATE	STATUS/REMARKS
CCSDS 401.0-B	Radio Frequency and Modulation Systems—Part 1: Earth Stations and Spacecraft	January 1987	Original Issue
CCSDS 401.0-B	Radio Frequency and Modulation Systems—Part 1: Earth Stations and Spacecraft	September 1989	New RF and Mod. recommendations added to Book at September 1989 Ottawa Plenary.
CCSDS 401.0-B	Radio Frequency and Modulation Systems—Part 1: Earth Stations and Spacecraft	October 1991	Adds new recommendation 4.1.4
CCSDS 401.0-B	Radio Frequency and Modulation Systems—Part 1: Earth Stations and Spacecraft	May 1992	Adds new recommendations 2.4.11 and 3.4.3A
CCSDS 401.0-B	Radio Frequency and Modulation Systems—Part 1: Earth Stations and Spacecraft	June 1993	Adds new recommendations 2.4.13B, 4.1.5, 4.2.1; updates recommendation 2.3.8
CCSDS 401.0-B	Radio Frequency and Modulation Systems—Part 1: Earth Stations and Spacecraft	November 1994	Adds new 2.6.7B, 2.6.8B, 3.1.4A, and 3.3.4.
CCSDS 401.0-B	Radio Frequency and Modulation Systems—Part 1: Earth Stations and Spacecraft	May 1996	Adds new recommendations 3.6.1, 3.6.2, 4.2.2, and 4.2.3.
CCSDS 401.0-B	Radio Frequency and Modulation Systems—Part 1: Earth Stations and Spacecraft	May 1997	Adds new recommendations 2.4.8, 2.4.14A, 2.4.14B, 2.4.15A, 2.4.15B, 2.4.16, and 2.4.6.B.
CCSDS 401.0-B	Radio Frequency and Modulation Systems—Part 1: Earth Stations and Spacecraft	June 1998	Deletes recommendations 3.1.3A and 3.1.5B.
CCSDS 401.0-B	Radio Frequency and Modulation Systems—Part 1: Earth Stations and Spacecraft	May 1999	Adds new recommendations 2.2.7 and 2.4.12B; updates recommendation 2.4.12A.

Earth Stations and Spacecraft

DOCUMENT CONTROL (continued)

DOCUMENT	TITLE	DATE	STATUS/REMARKS
CCSDS 401.0-B	Radio Frequency and Modulation Systems—Part 1: Earth Stations and Spacecraft	May 2000	Updates recommendations 3.1.1, 3.1.2A, 3.1.6B, and 3.2.1 (changed to 3.2.1A).
CCSDS 401.0-B	Radio Frequency and Modulation Systems—Part 1: Earth Stations and Spacecraft	June 2001	Adds recommendations 2.4.17A, 2.4.17B, and 2.4.18
CCSDS 401.0-B	Radio Frequency and Modulation Systems—Part 1: Earth Stations and Spacecraft	March 2003	Updates recommendations 2.4.3, 2.4.8, and 2.6.7B; deletes recommendations 2.4.4, 2.4.5, 3.3.4; updates 5.2.
CCSDS 401.0-B	Radio Frequency and Modulation Systems—Part 1: Earth Stations and Spacecraft	December 2003	Adds recommendation 2.2.8.
CCSDS 401.0-B	Radio Frequency and Modulation Systems—Part 1: Earth Stations and Spacecraft, Recommended Standard, Issue 15	September 2005	Updates the following recommendations: 2.1.8B, 2.2.4, 2.2.6, 2.3.3A, 2.3.5, 2.4.2, 2.4.10, 2.4.14A, 2.4.14B, 2.4.15A, 2.4.15B, 2.4.16, 2.4.6, 2.4.7, 2.4.9, 2.5.6B, 3.1.1, 3.1.6B, 3.2.1A, 3.3.1, 3.3.2A, 3.6.2A, 4.1.5, 4.2.1, 4.2.2, 4.2.3; updates terminology, 5.1
CCSDS 401.0-B	Radio Frequency and Modulation Systems—Part 1: Earth Stations and Spacecraft, Recommended Standard, Issue 16	March 2006	Adds new recommendations 2.5.1B and 3.1.2B; updates recommendations 2.1.3B, 2.1.4B, 2.1.7B, 2.3.2, 2.3.3A, 2.3.3B, 2.3.4A, 2.3.4B, 2.4.6, 2.4.11, 2.4.14B, 2.4.17B, and 3.3.3A; deletes recommendation 2.6.12

Earth Stations and Spacecraft

DOCUMENT CONTROL (continued)

DOCUMENT	TITLE	DATE	STATUS/REMARKS
CCSDS 401.0-B	Radio Frequency and Modulation Systems—Part 1: Earth Stations and Spacecraft, Recommended Standard, Issue 17	July 2006	Adds new recommendations 2.4.19, 2.6.9A, 2.6.10A; updates recommendations 2.2.7, 2.4.12B, 2.4.18, 4.2.1; updates subsection 5.1.
CCSDS 401.0-B	Radio Frequency and Modulation Systems—Part 1: Earth Stations and Spacecraft, Recommended Standard, Issue 18	December 2007	Adds new recommendation 2.4.20B; updates recommendations 2.4.12A, 2.4.12B, 2.6.8B.
CCSDS 401.0-B	Radio Frequency and Modulation Systems—Part 1: Earth Stations and Spacecraft, Recommended Standard, Issue 19	July 2008	Updates recommendations 2.2.3, 2.4.2, 2.4.17A, 2.4.17B, and 3.5.1.

NOTE – Changes from the previous issue are flagged with change bars in the inside margin.

Earth Stations and Spacecraft

REFERENCES

- [1] *Procedures Manual for the Consultative Committee for Space Data Systems*. CCSDS A00.0-Y-9. Yellow Book. Issue 9. Washington, D.C.: CCSDS, November 2003.
- [2] *Radio Frequency and Modulation—Part 1: Earth Stations*. Report Concerning Space Data System Standards, CCSDS 411.0-G-3. Green Book. Issue 3. Washington, D.C.: CCSDS, May 1997.
- [3] *Radio Regulations*, International Telecommunication Union, Geneva, Switzerland, 1992.
- [4] *Recommendations and Reports of the CCIR*, 1986 Plenary Assembly, Dubrovnik, Yugoslavia, 1986.

The latest issues of CCSDS documents may be obtained from the CCSDS Secretariat at the address indicated on page i. ■

Earth Stations and Spacecraft

CONTENTS

SECTION NO.	TITLE	ISSUE DATE	PAGE NO.
	AUTHORITY	07-06	i
	STATEMENT OF INTENT	07-06	ii
	FOREWORD.....	07-06	iii
	DOCUMENT CONTROL	07-06	v
	REFERENCES	07-06	vii
1.0	INTRODUCTION.....	06-93	1.0-1
1.1	PURPOSE	06-93	1.0-1
1.2	SCOPE.....	06-93	1.0-1
1.3	APPLICABILITY	06-93	1.0-1
1.4	DOCUMENT FORMAT	06-93	1.0-1
1.5	DEEP SPACE AND NON-DEEP SPACE	06-93	1.0-3
2.0	TECHNICAL RECOMMENDATIONS.....	06-93	2.0-1
	EARTH-TO-SPACE RF RECOMMENDATION SUMMARY	03-06	2.0-2
	TELECOMMAND RECOMMENDATION SUMMARY.....	12-03	2.0-3
	SPACE-TO-EARTH RF RECOMMENDATION SUMMARY	11-94	2.0-4
	TELEMETRY RECOMMENDATION SUMMARY	07-06	2.0-5
	RADIO METRIC RECOMMENDATION SUMMARY	03-06	2.0-6
	SPACECRAFT RECOMMENDATION SUMMARY.....	07-06	2.0-7
2.1	EARTH-TO-SPACE RF RECOMMENDATIONS		
2.1.1	RF CARRIER MODULATION OF THE EARTH-TO-SPACE LINK.....	01-87	2.1.1-1
2.1.2	POLARIZATION OF EARTH-TO-SPACE LINKS	01-87	2.1.2-1

Earth Stations and Spacecraft

CONTENTS (Continued)

SECTION NO.	TITLE	ISSUE DATE	PAGE NO.
2.1	EARTH-TO-SPACE RF RECOMMENDATIONS (Continued)		
2.1.3A	TRANSMITTER FREQUENCY SWEEP RANGE ON EARTH-TO-SPACE LINK, CATEGORY A.....	01-87	2.1.3A-1
2.1.3B	TRANSMITTER FREQUENCY SWEEP RANGE ON EARTH-TO-SPACE LINK, CATEGORY B.....	03-06	2.1.3B-1
2.1.4A	TRANSMITTER FREQUENCY SWEEP RATE ON EARTH-TO-SPACE LINK, CATEGORY A.....	01-87	2.1.4A-1
2.1.4.B	TRANSMITTER FREQUENCY SWEEP RATE ON EARTH-TO-SPACE LINK, CATEGORY B.....	03-06	2.1.4B-1
2.1.5	RELATIONSHIP OF MODULATOR INPUT VOLTAGE TO RESULTANT RF CARRIER PHASE SHIFT.....	01-87	2.1.5-1
2.1.6	RF CARRIER SUPPRESSION ON EARTH-TO-SPACE LINKS FOR RESIDUAL CARRIER SYSTEMS.....	01-87	2.1.6-1
2.1.7B	OPERATIONAL AND EQUIPMENT CONSTRAINTS RESULTING FROM SIMULTANEOUS TELECOMMAND AND RANGING IN RESIDUAL CARRIER SYSTEMS, CATEGORY B.....	03-06	2.1.7B-1
2.1.8A	MINIMUM EARTH STATION TRANSMITTER FREQUENCY RESOLUTION FOR SPACECRAFT RECEIVER ACQUISITION, CATEGORY A	09-89	2.1.8A-1
2.1.8B	MINIMUM EARTH STATION TRANSMITTER FREQUENCY RESOLUTION FOR SPACECRAFT RECEIVER ACQUISITION, CATEGORY B.....	10-04	2.1.8B-1
2.2	TELECOMMAND RECOMMENDATIONS		
2.2.2	SUBCARRIERS IN TELECOMMAND SYSTEMS	01-87	2.2.2-1
2.2.3	CHOICE OF PULSE CODE MODULATION (PCM) FORMAT IN TELECOMMAND LINKS.....	07-08	2.2.3-1
2.2.4	LOW-RATE TELECOMMAND SYSTEMS	10-04	2.2.4-1
2.2.5	TELECOMMAND SUBCARRIER FREQUENCY STABILITY	01-87	2.2.5-1
2.2.6	SYMMETRY OF BASEBAND MODULATING WAVEFORMS....	10-04	2.2.6-1

Earth Stations and Spacecraft

CONTENTS (Continued)

SECTION NO.	TITLE	ISSUE DATE	PAGE NO.
2.2	TELECOMMAND RECOMMENDATIONS (Continued)		
2.2.7	MEDIUM-RATE TELECOMMAND SYSTEMS.....	07-06	2.2.7-1
2.2.8	SUPPRESSED CARRIER TELECOMMAND SYSTEMS	12-03	2.2.8-1
2.3	SPACE-TO-EARTH RF RECOMMENDATIONS		
2.3.1	RESIDUAL CARRIERS FOR LOW RATE TELEMTRY, SPACE-TO-EARTH LINKS.....	01-87	2.3.1-1
2.3.2	USE OF SUPPRESSED CARRIER MODULATIONS (BPSK/QPSK) FOR MEDIUM RATE TELEMTRY SPACE-TO-EARTH LINKS.....	03-06	2.3.2-1
2.3.3A	EARTH STATION RECEIVER ACQUISITION FREQUENCY SWEEP RANGE, CATEGORY A.....	03-06	2.3.3A-1
2.3.3B	EARTH STATION RECEIVER ACQUISITION FREQUENCY SWEEP RANGE, CATEGORY B.....	03-06	2.3.3B-1
2.3.4A	EARTH STATION RECEIVER ACQUISITION FREQUENCY SWEEP RATE, CATEGORY A	03-06	2.3.4A-1
2.3.4B	EARTH STATION RECEIVER ACQUISITION FREQUENCY SWEEP RATE, CATEGORY B	03-06	2.3.4B-1
2.3.5	POLARIZATION OF SPACE-TO-EARTH LINKS	12-04	2.3.5-1
2.3.6	RELATIONSHIP OF MODULATOR INPUT VOLTAGE TO RESULTANT RF CARRIER PHASE SHIFT	01-87	2.3.6-1
2.3.7	EARTH STATION OSCILLATOR REFERENCE FREQUENCY STABILITY.....	01-87	2.3.7-1
2.3.8	RF CARRIER SUPPRESSION ON SPACE-TO-EARTH LINKS FOR RESIDUAL CARRIER SYSTEMS.....	06-93	2.3.8-1
2.4	TELEMETRY RECOMMENDATIONS		
2.4.2	PULSE CODE MODULATION (PCM) FORMAT FOR SUPPRESSED CARRIER SYSTEMS	07-08	2.4.2-1
2.4.3	SUBCARRIERS IN LOW BIT RATE RESIDUAL CARRIER TELEMETRY SYSTEMS.....	03-03	2.4.3-1

Earth Stations and Spacecraft

CONTENTS (Continued)

SECTION NO.	TITLE	ISSUE DATE	PAGE NO.
2.4	TELEMETRY RECOMMENDATIONS (Continued)		
2.4.4	PSK MODULATION FOR TELEMETRY SUBCARRIERS (DELETED)	03-03	2.4.4-1
2.4.5	TELEMETRY SUBCARRIER WAVEFORMS (DELETED).....	03-03	2.4.5-1
2.4.6	TELEMETRY SUBCARRIER FREQUENCY STABILITY	03-06	2.4.6-1
2.4.7	CHOICE OF PCM WAVEFORMS IN RESIDUAL CARRIER TELEMETRY SYSTEMS.....	10-04	2.4.7-1
2.4.8	MAXIMUM PERMISSIBLE SYMBOL ASYMMETRY FOR DIGITAL SIGNALS AT THE INPUT TO THE RF MODULATOR	03-03	2.4.8-1
2.4.9	MINIMUM MODULATED SYMBOL TRANSITION DENSITY ON THE SPACE-TO-EARTH LINK	10-04	2.4.9-1
2.4.10	CHANNEL INPUT AND CODING CONVENTIONS FOR QPSK SYSTEMS	08-05	2.4.10-1
2.4.11	PHASE-AMBIGUITY RESOLUTION FOR QPSK/ OQPSK MODULATION SYSTEMS USING A SINGLE DATA SOURCE	03-06	2.4.11-1
2.4.12A	MAXIMUM PERMISSIBLE PHASE AND AMPLITUDE IMBALANCES FOR SUPPRESSED CARRIER (BPSK/(O)QPSK/GMSK) RF MODULATORS FOR SPACE-TO-EARTH LINKS, CATEGORY A	12-07	2.4.12A-1
2.4.12B	MAXIMUM PERMISSIBLE PHASE AND AMPLITUDE IMBALANCES FOR SUPPRESSED CARRIER (BPSK/(O)QPSK/GMSK) RF MODULATORS FOR SPACE-TO-EARTH LINKS, CATEGORY B	12-07	2.4.12B-1
2.4.13B	MAXIMUM PERMISSIBLE PHASE AND AMPLITUDE IMBALANCES FOR SPACECRAFT SUBCARRIER MODULATORS, CATEGORY B.....	06-93	2.4.13B-1
2.4.14A	ALLOWABLE VALUES FOR TELEMETRY SUBCARRIER FREQUENCY-TO-SYMBOL RATE RATIOS FOR PCM/PSK/PM MODULATION IN THE 2 AND 8 GHz BANDS, CATEGORY A	10-04	2.4.14A-1
2.4.14B	ALLOWABLE VALUES FOR TELEMETRY SUBCARRIER FREQUENCY-TO-SYMBOL RATE RATIOS FOR PCM/PSK/PM MODULATION IN THE 2 AND 8 GHz BANDS, CATEGORY B	03-06	2.4.14B-1

Earth Stations and Spacecraft

CONTENTS (Continued)

SECTION NO.	TITLE	ISSUE DATE	PAGE NO.
2.4	TELEMETRY RECOMMENDATIONS (Continued)		
2.4.15A	MINIMUM SYMBOL RATE FOR PCM/PM/Bi- ϕ MODULATION ON A RESIDUAL RF CARRIER, CATEGORY A	10-04	2.4.15A-1
2.4.15B	MINIMUM SYMBOL RATE FOR PCM/PM/Bi- ϕ MODULATION ON A RESIDUAL RF CARRIER, CATEGORY B	10-04	2.4.15B-1
2.4.16	MAXIMUM PERMISSIBLE SPURIOUS EMISSIONS	10-04	2.4.16-1
2.4.17A	MODULATION METHODS FOR HIGH SYMBOL RATE TRANSMISSIONS, SPACE RESEARCH, SPACE-TO-EARTH, CATEGORY A	07-08	2.4.17A-1
2.4.17B	MODULATION METHODS AT HIGH SYMBOL RATE TRANSMISSIONS, SPACE RESEARCH, SPACE-TO-EARTH, CATEGORY B.....	07-08	2.4.17B-1
2.4.18	MODULATION METHODS AT HIGH SYMBOL RATE TRANSMISSIONS, EARTH EXPLORATION SATELLITES (EES) 8 GHZ BAND, SPACE-TO-EARTH.....	07-06	2.4.18-1
2.4.19	TELEMETRY SYMBOL RATE STABILITY IN SUPPRESSED CARRIER TELEMETRY SYSTEMS.....	07-06	2.4.19-1
2.4.20B	MODULATION METHODS AT HIGH SYMBOL RATE TRANSMISSIONS FOR THE 31.8-32.3 GHz BAND, SPACE RESEARCH, SPACE-TO-EARTH, CATEGORY B	12-07	2.4.20B-1
2.5	RADIO METRIC RECOMMENDATIONS		
2.5.1A	MINIMUM EARTH STATION GROUP DELAY CALIBRATION ACCURACY, CATEGORY A	09-89	2.5.1A-1
2.5.1B	MINIMUM EARTH STATION GROUP DELAY CALIBRATION ACCURACY, CATEGORY B.....	03-06	2.5.1B-1
2.5.2A	MINIMUM EARTH STATION RANGING GROUP DELAY STABILITY, CATEGORY A	09-89	2.5.2A-1
2.5.2B	MINIMUM EARTH STATION RANGING GROUP DELAY STABILITY, CATEGORY B	09-89	2.5.2B-1

Earth Stations and Spacecraft

CONTENTS (Continued)

SECTION NO.	TITLE	ISSUE DATE	PAGE NO.
2.5.3A	MINIMUM SPACECRAFT RANGING CHANNEL GROUP DELAY STABILITY, CATEGORY A.....	09-89	2.5.3A-1
2.5	RADIO METRIC RECOMMENDATIONS (Continued)		
2.5.3B	MINIMUM SPACECRAFT RANGING CHANNEL GROUP DELAY STABILITY, CATEGORY B.....	09-89	2.5.3B-1
2.5.4A	RANGING TRANSPONDER BANDWIDTH FOR RESIDUAL CARRIER SYSTEMS, CATEGORY A.....	09-89	2.5.4A-1
2.5.4B	RANGING TRANSPONDER BANDWIDTH FOR RESIDUAL CARRIER SYSTEMS, CATEGORY B.....	09-89	2.5.4B-1
2.5.5A	PN CODE PHASE SHIFT STABILITY REQUIRED IN SPACECRAFT SPREAD SPECTRUM REGENERATIVE RANGING TRANSPONDERS, CATEGORY A.....	09-89	2.5.5A-1
2.5.6B	DIFFERENTIAL ONE-WAY RANGING FOR SPACE-TO-EARTH LINKS IN ANGULAR SPACECRAFT POSITION DETERMINATION, CATEGORY B.....	03-05	2.5.6B-1
2.6	SPACECRAFT RECOMMENDATIONS		
2.6.1	TRANSPONDER TURNAROUND FREQUENCY RATIOS FOR THE 2025 - 2120 MHz AND 2200 - 2300 MHz BANDS.....	01-87	2.6.1-1
2.6.2	TRANSPONDER TURNAROUND FREQUENCY RATIOS FOR THE 7145 - 7235 MHz AND 8400 - 8500 MHz BANDS.....	01-87	2.6.2-1
2.6.3A	TRANSPONDER TURNAROUND FREQUENCY RATIOS FOR THE 2025 - 2110 MHz AND 8450 - 8500 MHz BANDS, CATEGORY A.....	01-87	2.6.3A-1
2.6.4A	TRANSPONDER TURNAROUND FREQUENCY RATIOS FOR THE 7190 - 7235 MHz AND 2200 - 2290 MHz BANDS, CATEGORY A.....	01-87	2.6.4A-1
2.6.5B	TRANSPONDER TURNAROUND FREQUENCY RATIOS FOR THE 2110 - 2120 MHz AND 8400 - 8450 MHz BANDS, CATEGORY B.....	01-87	2.6.5B-1
2.6.6B	TRANSPONDER TURNAROUND FREQUENCY RATIOS FOR THE 7145 - 7190 MHz AND 2290 - 2300 MHz BANDS, CATEGORY B.....	01-87	2.6.6B-1

Earth Stations and Spacecraft

CONTENTS (Continued)

SECTION NO.	TITLE	ISSUE DATE	PAGE NO.
2.6.7B	TRANSPONDER TURNAROUND FREQUENCY RATIOS FOR THE 7145 - 7190 MHz AND 31.8 - 32.3 GHz BANDS, CATEGORY B	03-03	2.6.7B-1
2.6	SPACECRAFT RECOMMENDATIONS (Continued)		
2.6.8B	TRANSPONDER TURNAROUND FREQUENCY RATIOS FOR THE 31.8 - 32.3 GHz AND 34.2 - 34.7 GHz BANDS, CATEGORY B	12-07	2.6.8B-1
2.6.9A	TRANSPONDER TURNAROUND FREQUENCY RATIOS FOR THE 7190 – 7235 MHz AND 25.5 – 27.0 GHz BANDS, CATEGORY A	07-06	2.6.9A-1
2.6.10A	TRANSPONDER TURNAROUND FREQUENCY RATIOS FOR THE 2025 – 2110 MHz AND 25.5 – 27.0 GHz BANDS, CATEGORY A	07-06	2.6.10A-1
2.6.12	SPACECRAFT TRANSPONDER IF AND AGC AMPLIFIER BANDWIDTHS FOR COHERENT OPERATION (DELETED)	03-06	2.6.12-1
3.0	POLICY RECOMMENDATIONS	06-93	3.0-1
	FREQUENCY UTILIZATION RECOMMENDATION SUMMARY	03-06	3.0-2
	POWER LIMITATIONS RECOMMENDATION SUMMARY	05-00	3.0-3
	MODULATION METHODS RECOMMENDATION SUMMARY	03-03	3.0-4
	OPERATIONAL PROCEDURES RECOMMENDATION SUMMARY	11-94	3.0-5
	TESTING RECOMMENDATION SUMMARY	11-94	3.0-6
	SPACECRAFT SYSTEMS RECOMMENDATION SUMMARY	05-96	3.0-7
3.1	FREQUENCY UTILIZATION		
3.1.1	EFFICIENT UTILIZATION OF THE 2 GHz BANDS FOR SPACE OPERATION.....	10-04	3.1.1-1
3.1.2A	USE OF THE 8450 - 8500 MHz BAND FOR SPACE RESEARCH, CATEGORY A.....	05-00	3.1.2A-1

Earth Stations and Spacecraft

CONTENTS (Continued)

SECTION NO.	TITLE	ISSUE DATE	PAGE NO.
3.1.2B	USE OF THE 8400 — 8450 MHz BAND FOR SPACE RESEARCH, CATEGORY B.....	03-06	3.1.2B-1
3.1	FREQUENCY UTILIZATION (Continued)		
3.1.3A	USE OF THE 13.25 - 15.35 GHz BANDS FOR SPACE RESEARCH, CATEGORY A (DELETED).....	06-98	3.1.3A-1
3.1.4A	CONSTRAINTS ON THE USE OF THE 14.00 - 15.35 GHz AND THE 16.6 - 17.1 GHz BANDS FOR SPACE RESEARCH, CATEGORY A.....	11-94	3.1.4A-1
3.1.5B	USE OF THE 31.8 - 34.7 GHz BANDS FOR SPACE RESEARCH, CATEGORY B (DELETED).....	06-98	3.1.5B-1
3.1.6B	CHANNEL FREQUENCY PLAN FOR 2, 7, 8, 32, AND 34 GHz, CATEGORY B	10-04	3.1.6B-1
3.2	POWER LIMITATIONS		
3.2.1A	LIMITATIONS ON EARTH-TO-SPACE LINK POWER LEVELS, CATEGORY A.....	10-04	3.2.1A-1
3.3	MODULATION METHODS		
3.3.1	OPTIMAL RANGING MODULATION WAVEFORMS FOR SIMULTANEOUS RANGING, TELECOMMANDING AND TELEMETRY OPERATIONS	10-04	3.3.1-1
3.3.2A	CRITERIA FOR USE OF DIRECT SEQUENCE SPREAD SPECTRUM MODULATION, CATEGORY A	10-04	3.3.2A-1
3.3.3A	PREFERRED MODULATION FORMATS FOR SUPPRESSED CARRIER SYSTEMS, CATEGORY A.....	03-06	3.3.3A-1
3.3.4	USE OF SUBCARRIERS ON SPACECRAFT TELEMETRY CHANNELS (DELETED)	03-03	3.3.4-1
3.4	OPERATIONAL PROCEDURES		
3.4.1	SIMULTANEOUS TELECOMMAND, TELEMETRY, AND RANGING OPERATIONS.....	09-89	3.4.1-1

Earth Stations and Spacecraft

CONTENTS (Continued)

SECTION NO.	TITLE	ISSUE DATE	PAGE NO.
3.4.2	CHARGED PARTICLE MEASUREMENTS IN THE TELECOMMUNICATIONS PROPAGATION PATH	09-89	3.4.2-1
3.4	OPERATIONAL PROCEDURES (Continued)		
3.4.3A	OPTIMAL CHARGED PARTICLE CALIBRATION TECHNIQUES FOR RANGING DATA UNDER VARIOUS PROPAGATION CONDITIONS, SINGLE STATION TRACKING, CATEGORY A.....	05-92	3.4.3A-1
3.5	TESTING RECOMMENDATIONS		
3.5.1	MINIMUM SET OF SPACECRAFT - EARTH STATION TESTS REQUIRED TO ENSURE COMPATIBILITY	07-08	3.5.1-1
3.6	SPACECRAFT SYSTEMS		
3.6.1A	INTERFERENCE REDUCTION IN THE 2200 - 2290 MHz BANDS, CATEGORY A	05-96	3.6.1A-1
3.6.2A	INTERFERENCE FROM SPACE-TO-SPACE LINKS BETWEEN NON-GEOSTATIONARY SATELLITES TO OTHER SPACE SYSTEMS IN THE 2025 - 2110 AND 2200 - 2290 MHz BANDS, CATEGORY A.....	10-04	3.6.2A-1
4.0	PROCEDURAL RECOMMENDATIONS.....	06-93	4.0-1
	DESIGN TOOLS RECOMMENDATION SUMMARY	11-94	4.0-2
	COMPUTATIONAL ALGORITHMS RECOMMENDATION SUMMARY	05-96	4.0-3
4.1	DESIGN TOOLS		
4.1.1	SELECTION OF OPTIMUM MODULATION INDICES FOR SIMULTANEOUS RANGING, TELECOMMAND, AND TELEMETRY OPERATIONS	09-89	4.1.1-1
4.1.2	TELECOMMUNICATIONS LINK DESIGN CONTROL TABLE	09-89	4.1.2-1
4.1.3	STANDARD TERMINOLOGY FOR TELECOMMUNICATIONS LINK PERFORMANCE CALCULATIONS	09-89	4.1.3-1

Earth Stations and Spacecraft

CONTENTS (Continued)

SECTION NO.	TITLE	ISSUE DATE	PAGE NO.
4.1	DESIGN TOOLS (Continued)		
4.1.4	DEFAULT PROBABILITY DENSITY FUNCTIONS FOR LINK COMPUTATION IN THE CCSDS TELECOMMUNICATIONS LINK DESIGN CONTROL TABLE.....	10-91	4.1.4-1
4.1.5	COMPUTATIONAL TECHNIQUE FOR THE MEAN AND VARIANCE OF THE MODULATION LOSSES FOUND IN THE CCSDS TELECOMMUNICATION LINK DESIGN CONTROL TABLE.....	10-04	4.1.5-1
4.2	COMPUTATIONAL ALGORITHMS		
4.2.1	COMPUTATIONAL METHOD FOR DETERMINING THE OCCUPIED BANDWIDTH OF UNFILTERED PCM/PM SIGNALS	07-06	4.2.1-1
4.2.2	COMPUTATIONAL METHOD FOR DETERMINING THE OCCUPIED BANDWIDTH OF UNFILTERED PCM/PSK/PM MODULATION WITH A SINEWAVE SUBCARRIER.....	10-04	4.2.2-1
4.2.3	COMPUTATIONAL METHOD FOR DETERMINING THE OCCUPIED BANDWIDTH OF UNFILTERED PCM/PSK/PM MODULATION WITH A SQUAREWAVE SUBCARRIER	10-04	4.2.3-1
5.0	TERMINOLOGY AND GLOSSARY	09-89	5.0-1
5.1	TERMINOLOGY	07-06	5.1-1
5.2	GLOSSARY.....	03-03	5.2-1

Earth Stations and Spacecraft

1.0 INTRODUCTION

1.1 PURPOSE

This document recommends standards for radio frequency and modulation systems operated by the Consultative Committee for Space Data Systems (CCSDS) member and observer agencies.

1.2 SCOPE

Recommendations contained in this document, *Radio Frequency and Modulation Systems, Part 1*, focus upon the standardization of RF and modulation systems for Earth stations and spacecraft. *Part 2*, when completed, will comprise Recommendations relating to data relay satellite systems. Unlike the CCSDS *Radio Frequency and Modulation Report*, Reference [2], these Recommendations describe the capabilities, policies, and procedures that the CCSDS agencies believe will be needed in future years. By proposing specific characteristics and attributes for subjects in these categories, the CCSDS hopes that the ensuing designs will be sufficiently similar so as to permit cross support of one agency's spacecraft by another agency's network.

These Recommendations are complementary to the information contained in the *RF and Modulation Report*. To obtain a complete understanding of an agency's tracking facilities, readers should consult both documents. The *Report* describes the RF and modulation characteristics of spacecraft tracking systems that the CCSDS member and observer agencies are planning for the mid-1990 time period. It comprises a multiplicity of tables summarizing the technical characteristics of those systems.

These Recommendations do not provide specific designs. Rather they describe certain capabilities and provide technical characteristics in sufficient detail so that an agency may design compatible equipment. Guidelines are also provided for the use of agencies' RF and modulation systems, as well as their use of the RF spectrum. Because an ability to provide cross support implies some standardization of design and operations, certain procedural Recommendations have been included to assist in these areas. Recommendations are assigned to one of three sections depending upon whether their primary focus is technical, policy, or procedural in nature.

These Recommendations are intended to promote an orderly transition to RF and modulation systems that are internationally compatible. The CCSDS believes that this course will not only assure better engineering practices but, also, that it will facilitate international cross support agreements.

1.3 APPLICABILITY

These Recommendations apply to future implementation of RF and modulation systems. In combination with the *RF and Modulation Report*, Reference [2], this document describes the physical transport system used to carry data to and from spacecraft and Earth stations.

1.4 DOCUMENT FORMAT

These introductory remarks are followed by three sections containing technical, policy, and procedural Recommendations, respectively. Often, it is not obvious to which section a Recommendation belongs because it may be concerned with more than one area. The decision usually turns upon whether the primary focus is quantitative, directive, or instructive.

Earth Stations and Spacecraft

Section 2 contains Technical Recommendations. Following the format established in the CCSDS *RF and Modulation Report*, technical Recommendations are subdivided into groups representing the various subsystems. These are:

- | | | | |
|-----|---------------------------------------|-----|---------------------|
| 2.1 | <i>Earth-to-Space Radio Frequency</i> | 2.4 | <i>Telemetry</i> |
| 2.2 | <i>Telecommand</i> | 2.5 | <i>Radio Metric</i> |
| 2.3 | <i>Space-to-Earth Radio Frequency</i> | 2.6 | <i>Spacecraft</i> |

Recommendations pertaining to each of these subjects are grouped together for easy accessibility. This approach facilitates cross referencing with the *Report*. If a reader wishes to determine whether an agency follows a specific CCSDS Recommendation, he need only turn to the corresponding section in the *Report* to determine that agency's capabilities.

Section 3 comprises Policy Recommendations. Because of the requirement for sharing the radio frequency spectrum, it is desirable to establish guidelines to promote its efficient use. Accordingly, these Recommendations are directive in nature and are principally concerned with operational aspects. Specific sections are:

- | | | | |
|-----|------------------------------|-----|--------------------------------|
| 3.1 | <i>Frequency Utilization</i> | 3.4 | <i>Operational Procedures</i> |
| 3.2 | <i>Power Limitations</i> | 3.5 | <i>Testing Recommendations</i> |
| 3.3 | <i>Modulation Methods</i> | 3.6 | <i>Spacecraft Systems</i> |

Section 4 holds Procedural Recommendations. Here will be found Recommendations intended to assist agencies with procedures or processes. At this juncture, only two subsections have been identified. These are:

- | | | | |
|-----|---------------------|-----|---------------------------------|
| 4.1 | <i>Design Tools</i> | 4.2 | <i>Computational Algorithms</i> |
|-----|---------------------|-----|---------------------------------|

As additional procedural topics are identified, this section will be expanded with appropriate subsections.

Section 5 defines Terms and provides a Glossary for acronyms used in these Recommendations. This section is intended as an aid for readers to facilitate a uniform interpretation of the Recommendations. Two subsections are required:

- | | | | |
|-----|--------------------|-----|-----------------|
| 5.1 | <i>Terminology</i> | 5.2 | <i>Glossary</i> |
|-----|--------------------|-----|-----------------|

Because the Recommendations are designed to be easily removable from this book to facilitate copying, a unique page numbering system has been employed. Recommendation page numbers contain information about the section, subsection, position, mission category, and page number. Thus, Page 2.5.3A-1 tells the reader, in order, that this is: a Technical Recommendation (2), for Radio Metric systems (5), the third in that subsection (3), concerned with Category A missions (A), the first page of that Recommendation (1). This numbering system is intended to avoid confusion and errors when returning pages to the book by uniquely describing the position of each page in the document.

Unlike other CCSDS Recommendations which focus upon specific topics such as channel coding or SFDUs, this document contains several subjects related to radio frequency and modulation systems. To promote brevity, clarity, and expandability, the authors have adopted a Recommendation format which is similar to the one used by the International Telecommunications Union's (ITU) International Radio Consultative Committee (CCIR).

Each Recommendation consists of brief statements and generally requires only one or two pages. Reasons justifying each Recommendation are set forth in clear, crisp sentences. When appropriate, additional information providing the rationale for a Recommendation is included as an annex to this document. This modular format permits inclusion of additional Recommendations as the CCSDS agencies' RF and modulation systems grow and as technology matures.

Earth Stations and Spacecraft

1.5 DEEP SPACE AND NON-DEEP SPACE

Much of the radio frequency standardization has already been accomplished by the International Telecommunications Union (ITU) and will be found in the Radio Regulations. The provisions contained in the ITU Radio Regulations, as well as applicable CCIR documents, are adopted and incorporated here by reference.

Four *radiocommunication services* are of interest to the CCSDS. In accordance with the ITU definitions, these are the Space Research Service, the Space Operation Service, the Earth Exploration Satellite Service, and the Meteorological Satellite Service.

Within the Space Research Service, a distinction is made between *Deep Space* and *non-Deep Space* spacecraft. Those bands allocated to *Space Research/Deep Space* shall only be used by spacecraft engaged in interplanetary research, whose range exceeds a specified distance.

Earth station-spacecraft distance is important for two reasons. First, certain frequencies are reserved for spacecraft operating in *Deep Space*. Second, the RF and modulation characteristics may be different for the two categories.

Formerly, the Radio Regulations set the *Deep Space* boundary at lunar distance. However, the advent of spacecraft in highly elliptical Earth orbits that go beyond lunar distance, or which may be in orbits around the sun-Earth libration points, resulted in non-optimum use of the *Deep Space* bands when frequency assignments for these missions were based upon the former definition.

In October 1988, the World Administrative Radio Conference (WARC) ORB-88 revised the boundary for *Deep Space* contained in Article 1 of the ITU Radio Regulations. The new boundary for *Deep Space*, which became effective on 16 March 1990, has been established to be at a distance equal to, or greater than, 2.0×10^6 km.

While the Radio Regulations contain a definition for *Deep Space*, they do not specifically name that zone lying closer to the Earth. Thus, there is no internationally recognized term for *non-Deep Space* missions.

Several years ago, the CCSDS recognized the deficiencies with the ITU's lunar distance *Deep Space* boundary. Accordingly, CCSDS members agreed among themselves to establish the *Deep Space* boundary at 2.0×10^6 km whenever that was possible under the then existing Radio Regulations. To avoid confusion with the ITU's definition for *Deep Space*, as well as to simplify the nomenclature for missions at any distance, the CCSDS defined the following mission categories:

- | | |
|------------|---|
| Category A | Those missions having an altitude above the Earth of less than, 2.0×10^6 km. |
| Category B | Those missions having an altitude above the Earth of greater than, or equal to, 2.0×10^6 km. |

Earth Stations and Spacecraft

Figure 1.5-1 pictorially depicts the Category A and B mission regions.

Because this terminology has become well established over the years, and because the ITU has still failed to define that region lying closer to Earth than 2.0×10^6 km, the CCSDS will continue to use the two Categories to represent the applicability of a Recommendation to a specific class of mission.

Therefore, the letter A or B following the Recommendation number means that the Recommendation applies solely to Category A or Category B missions, respectively. If the Recommendation number stands alone, with neither an A or B following, then that Recommendation applies equally to both Category A and Category B missions.

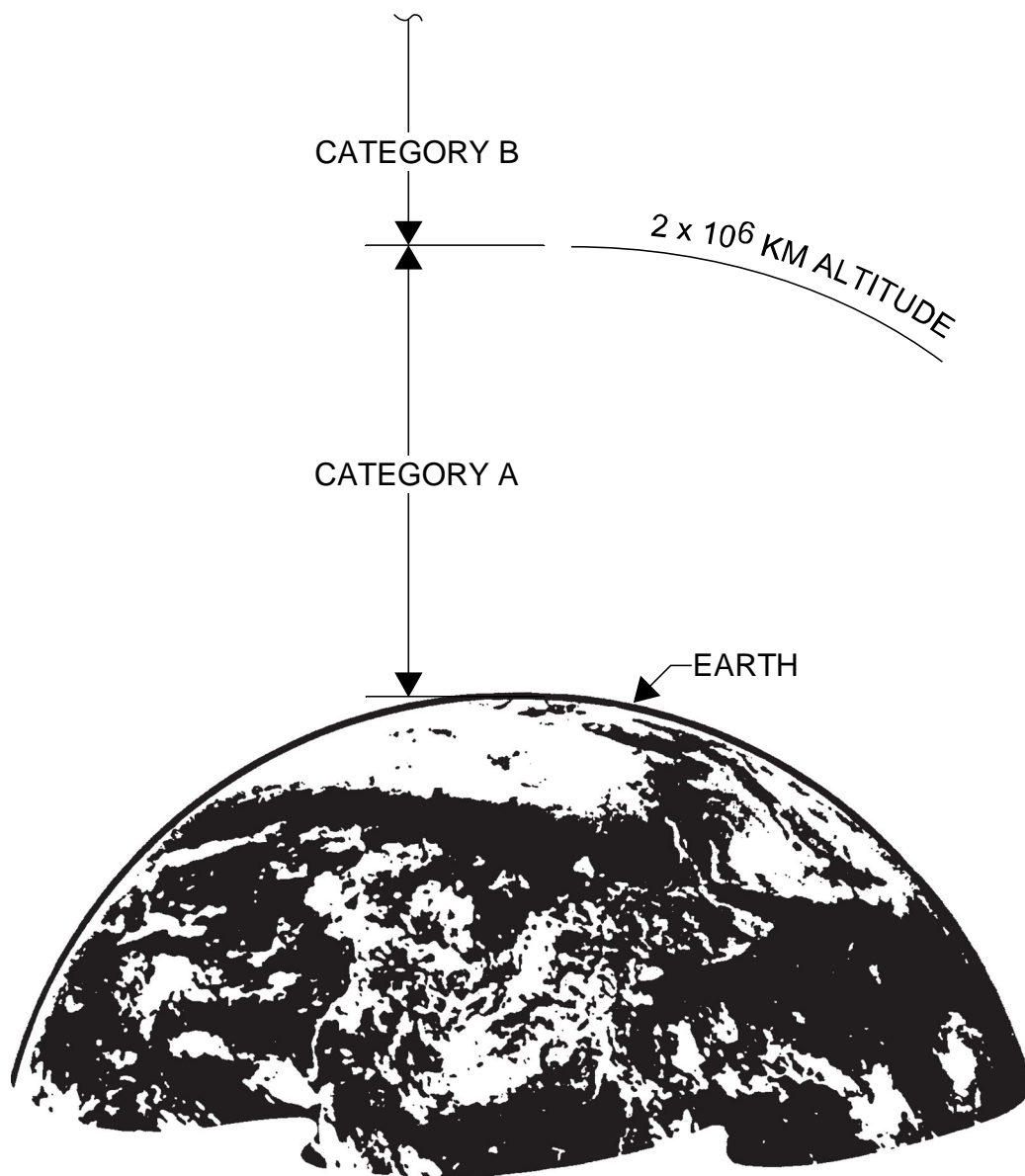

Figure 1.5-1: Mission Categories

Earth Stations and Spacecraft

2.0 TECHNICAL RECOMMENDATIONS

Section 2 focuses upon the technical characteristics of RF and modulation systems for Earth stations and spacecraft. Each recommended standard delineates a specific capability which the CCSDS agencies believe will be needed in future years. Some suggested standards argue for retaining existing facilities, while others propose developing systems not presently used by any agency. The goal is to set forth recommended standards with which the agencies can create a group of uniform capabilities.

To facilitate the document's use, this section has been subdivided into six modules, each containing an individual subject:

2.1	<i>Earth-to-Space Radio Frequency</i>	2.4	<i>Telemetry</i>
2.2	<i>Telecommand</i>	2.5	<i>Radio Metric</i>
2.3	<i>Space-to-Earth Radio Frequency</i>	2.6	<i>Spacecraft</i>

Note that these subsections are identical to, and have been arranged in the same order as, those found in the CCSDS Radio Frequency and Modulation Report. However, an additional subsection for spacecraft has been included. Here, one can find those characteristics pertaining to spacecraft radio frequency and modulation systems.

Six summary tables corresponding to the six modules follow these introductory remarks. These tables contain the subject matter of each recommendation, its number, and a summary description. Using these tables, the reader can quickly locate specific recommendations contained in Section 2.

Earth Stations and Spacecraft

TELEMETRY RECOMMENDATION SUMMARY

REC. NO.	RECOMMENDED CHARACTERISTICS	RECOMMENDATION SUMMARY
2.4.1	Reserved	
2.4.2	NRZ-M (DNRZ) Modulation	Use with suppressed carrier systems.
2.4.3	Subcarriers	Use with very low rate residual carrier subsystems.
2.4.4		Deleted.
2.4.5		Deleted.
2.4.6	± 200 ppm; $\pm 1 \times 10^{-6}$; $\pm 2 \times 10^{-5}$	Subcarrier frequency offset and stabilities.
2.4.7	NRZ-L; SP-L	Choice of PCM waveforms in resid. carrier systems.
2.4.8	0.2 %	Max symbol asymmetry at RF modulator input.
2.4.9	64; 125/1000; 275/1000	Min Cat A, Cat B symbol transition densities.
2.4.10	00=0°; 01=90°; 11=180°; 10=270°	Channel coding conventions for QPSK systems.
2.4.11	Phase Ambiguity in QPSK Sys.	Use sync marker to resolve.
2.4.12A	5 Degrees; 0.5 dB	Max Cat A phase&l. BPSK/(O)QPSK/GMSK imbal.
2.4.12B	5 Degrees; 0.5 dB	Max Cat B phase&l. BPSK/(O)QPSK/GMSK imbal.
2.4.13B	2 Degrees; 0.2 dB	Max Cat B phase & amplitude subcar. mod. imbal.
2.4.14A	4 for freq. > 60 kHz	Cat A Subcarrier frequency-to-symbol ratios.
2.4.14B	5 for freq. > 60 kHz	Cat B Subcarrier frequency-to-symbol ratios.
2.4.15A	Operating Region	Min Cat A symbol rate for mod. on residual RF carrier.
2.4.15B	Operating Region	Min Cat B symbol rate for mod. on residual RF carrier.
2.4.16	≤ -60 dBc	Max spurious emissions.
2.4.17A	GMSK/OQPSK	Cat A modulation methods, high data rate transmissions.
2.4.17B	GMSK	Cat B modulation methods, high data rate transmissions.
2.4.18	4D 8PSK TCM/GMSK/OQPSK	EES modulation methods, high data rate transmissions.
2.4.19	± 100 ppm; $\pm 1 \times 10^{-6}$; $\pm 1 \times 10^{-5}$	Maximum symbol rate offset; minimum stability.
2.4.20B	GMSK (BT _S =0.5)	Cat B modulation methods, high symbol rate transmissions

Earth Stations and Spacecraft

2.1.1 RF CARRIER MODULATION OF THE EARTH-TO-SPACE LINK

The CCSDS,

considering

- (a) that most space agencies currently utilize spacecraft receivers employing phase-locked loops;
- (b) that conventional phase-locked loop receivers require a residual carrier to operate efficiently;
- (c) that phase modulation results in efficient demodulation;

recommends

that CCSDS agencies provide a capability to support phase modulation with a residual carrier for their Earth-to-space links.

Earth Stations and Spacecraft

2.1.2 POLARIZATION OF EARTH-TO-SPACE LINKS

The CCSDS,

considering

- (a) that a linear electric field polarization on links to spacecraft, having nearly omnidirectional antenna patterns, may vary considerably with aspect angle;
- (b) that the aspect angle of a near-Earth orbiting satellite varies greatly during a pass;
- (c) that for satellites having a stable linear polarization in the direction of the Earth station (e.g., geostationary satellites with suitable attitude stabilization or satellites using tracking antennas) the propagation effects such as Faraday rotation may cause substantial rotation in the received polarization at lower carrier frequencies;
- (d) that automatic correction of rotation in the Earth station's polarization adds undesirable complexity to the system;
- (e) that most existing Earth stations are equipped for RCP and LCP polarization;

recommends

- (1) that CCSDS agencies use circular polarization on their Earth-to-space RF links for telecommand and ranging;
- (2) that payload service links use circular polarization in those cases where TTC is carried out in the payload service band or where on-board antennas are shared with payload functions;
- (3) that the Earth station be designed to switch between LCP and RCP polarization without causing an interruption of the transmitted carrier exceeding 5 seconds in those cases where changes of polarization are desired.

Earth Stations and Spacecraft

2.1.3A TRANSMITTER FREQUENCY SWEEP RANGE ON EARTH-TO-SPACE LINKS, CATEGORY A

The CCSDS,

considering

- (a) that the Doppler frequency shift on the Earth-to-space link, resulting from relative motion between Earth stations and Category A spacecraft, can achieve values up to:

$$\begin{aligned} &\pm 80 \text{ kHz at 2 GHz} \\ &\pm 300 \text{ kHz at 7 GHz;} \end{aligned}$$

- (b) that the rest frequency uncertainties in spacecraft receivers are in the order of:

$$\begin{aligned} &\pm 50 \text{ kHz at 2 GHz} \\ &\pm 200 \text{ kHz at 7 GHz;} \end{aligned}$$

- (c) that the lock-in frequency range of spacecraft receivers is much smaller than the frequency deviations given in (a) and (b);

- (d) that the Doppler frequency shift can usually be predicted to an accuracy of better than ± 1 kHz;

- (e) that most of the spacecraft receivers have a tracking range up to:

$$\begin{aligned} &\pm 150 \text{ kHz at 2 GHz} \\ &\pm 500 \text{ kHz at 7 GHz;} \end{aligned}$$

- (f) that the acquisition time should be kept to a minimum;

recommends

that the Earth station's transmitter should have a minimum sweep range capability of at least:

$$\pm 1 \text{ kHz}$$

and a maximum sweep range capability of:

$$\begin{aligned} &\pm 150 \text{ kHz at 2 GHz} \\ &\pm 500 \text{ kHz at 7 GHz.} \end{aligned}$$

Earth Stations and Spacecraft

2.1.3B TRANSMITTER FREQUENCY SWEEP RANGE ON EARTH-TO-SPACE LINKS, CATEGORY B

The CCSDS,

considering

- (a) that the Doppler frequency shift on the Earth-to-space link, resulting from relative motion between Earth stations and category B spacecraft, can achieve values up to:

± 250 kHz at 2 GHz
 ± 900 kHz at 7 GHz
 ± 4 MHz at 34 GHz;

- (b) that the rest frequency uncertainties in spacecraft receivers are on the order of:

± 1 kHz at 2 GHz
 ± 4 kHz at 7 GHz
 ± 18 kHz at 34 GHz;

- (c) that the Doppler frequency shift can usually be predicted to an accuracy of ± 1 kHz;

- (d) that most of the spacecraft receivers have tracking ranges less than or equal to:

± 300 kHz at 2 GHz
 ± 1 MHz at 7 GHz
 ± 4 MHz at 34 GHz;

- (e) that the lock-in frequency range of spacecraft receivers is much smaller than the frequency deviations given in (a) and (b) above;

- (f) that the effect on the radio link, resulting from variation in the columnar charged-particle content, is generally negligible;

- (g) that the acquisition time should be kept to a minimum;

recommends

that the Earth station's transmitter should have a minimum sweep range capability of:

± 1 kHz at 2, 7, and 34 GHz

and a maximum sweep range capability of at least:

± 300 kHz at 2 GHz
 ± 1 MHz at 7 GHz
 ± 4 MHz at 34 GHz.

Earth Stations and Spacecraft

2.1.4A TRANSMITTER FREQUENCY SWEEP RATE ON EARTH-TO-SPACE LINKS, CATEGORY A

The CCSDS,

considering

- (a) that the rate of change of the Doppler frequency shift on the Earth-to-space link, resulting from relative motion between Earth stations and Category A spacecraft, is smaller than:

3 kHz/s at 2 GHz
10 kHz/s at 7 GHz;

- (b) that most of the spacecraft receivers have a phase-locked loop with a bandwidth ($2 B_{LO}$) in the range 200 Hz to 800 Hz at their threshold;
- (c) that the maximum permissible rate of input frequency variation for most types of spacecraft receivers is between 2 kHz/s and 30 kHz/s at their threshold;
- (d) that the frequency sweep rate on the Earth-to-space link should be chosen such that the total rate of frequency variation, resulting from both the transmitter's sweep rate and the orbital Doppler rate, does not unlock the spacecraft's phase-locked loop;
- (e) that the acquisition time should be kept to a minimum for each mission phase;

recommends

that the Earth station's transmitter should have a minimum frequency sweep rate capability of:

500 Hz/s

and a maximum frequency sweep rate capability of at least:

50 kHz/s.

Earth Stations and Spacecraft

2.1.4B TRANSMITTER FREQUENCY SWEEP RATE ON EARTH-TO-SPACE LINKS, CATEGORY B

The CCSDS,

considering

- (a) that the rate of change of the Doppler frequency shift on the Earth-to-space link, resulting from relative motion between Earth stations and category B spacecraft, is smaller than:

70 Hz/s at 2 GHz
240 Hz/s at 7 GHz
1200 Hz/s at 34 GHz;

- (b) that most of the spacecraft receivers have a phase-locked loop with a bandwidth ($2 B_{LO}$) in the range 10 Hz to 100 Hz at their threshold;
- (c) that the maximum permissible rate of input frequency variation for this type of spacecraft receiver is between 6 Hz/s and 1 kHz/s at its threshold;
- (d) that the maximum permissible rate of input frequency variation for signals above the receiver's threshold can be as much as 10 kHz/s;
- (e) that the frequency sweep rate on the Earth-to-space link should be chosen such that the total rate of frequency variation, resulting from both the transmitter's sweep rate and the orbital Doppler rate, does not unlock the spacecraft's phase-locked loop;
- (f) that the acquisition time should be kept to a minimum for each mission phase;

recommends

that the Earth station's transmitter should have a minimum frequency sweep rate capability of:

1 Hz/s

and a maximum frequency sweep rate capability of at least:

10 kHz/s.

Earth Stations and Spacecraft

2.1.5 RELATIONSHIP OF MODULATOR INPUT VOLTAGE TO RESULTANT RF CARRIER PHASE SHIFT

The CCSDS,

considering

that a clear relationship between the modulating signal and the RF carrier's phase is desirable to avoid unnecessary ambiguity problems;

recommends

that a positive-going voltage at the modulator input should result in an advance of the phase of the radio frequency signal.

NOTE:

1. This Recommendation is also filed as Rec. 401 (2.3.6) B-1.

Earth Stations and Spacecraft

**2.1.6 RF CARRIER SUPPRESSION ON EARTH-TO-SPACE LINKS FOR
RESIDUAL CARRIER SYSTEMS**

The CCSDS,

considering

that high modulation indices may make the residual carrier difficult to detect with a conventional phase-locked loop receiver;

recommends

that CCSDS agencies select modulation indices such that the reduction in carrier power, with respect to the total unmodulated carrier power, does not exceed 10 dB.

Earth Stations and Spacecraft

**2.1.7B OPERATIONAL AND EQUIPMENT CONSTRAINTS RESULTING FROM
SIMULTANEOUS TELECOMMAND AND RANGING IN RESIDUAL
CARRIER SYSTEMS, CATEGORY B**

The CCSDS,

considering

- (a) that coherent transmissions are generally employed for making range measurements to a Category B mission spacecraft;
- (b) that conventional phase locked loop receivers require a residual carrier component to operate properly;
- (c) that sufficient power must be reserved to the residual carrier so that the spacecraft receiver can track with an acceptable phase jitter;
- (d) that sufficient power must be allocated to the command data channel to obtain the required bit error rate;
- (e) that in two-way operation, the noise contained in the transponder's ranging channel bandwidth will be retransmitted to the Earth station along with the ranging signal;
- (f) that sufficient power must be allocated to the ranging signal to obtain the required accuracy and probability of error;
- (g) that some ranging systems permit the simultaneous transmission of several tone frequencies from the Earth station and that a proper choice of these frequencies will minimize the cross-modulation and interference to the telecommand signal by the ranging signal;
- (h) that transmission of a single, low frequency ranging tone by the Earth station may result in interference in the telecommand channel on the spacecraft;

recommends

- (1) that the telecommand modulation index shall not be less than 0.2 radians peak;
- (2) that the Earth station's ranging modulation index shall not exceed 1.4 radians peak;
- (3) that the telecommand subcarrier's period should be an integer subdivision of the data bits' period;
- (4) that, where necessary, each and every lower frequency ranging tone be chopped (modulo-2 added) with the highest frequency ranging tone.

Earth Stations and Spacecraft

**2.1.8A MINIMUM EARTH STATION TRANSMITTER FREQUENCY RESOLUTION
FOR SPACECRAFT RECEIVER ACQUISITION, CATEGORY A**

The CCSDS,

considering

- (a) that Category A spacecraft receivers typically have phase-locked loop bandwidths ($2 B_{LO}$) in the range of 200 to 800 Hz at their thresholds;
- (b) that, for spacecraft receivers having a second order phase-locked-loop with the threshold bandwidths shown in (a), the frequency lock-in range is typically 267 to 1067 Hz;
- (c) that steps in Earth station's transmitter frequency which exceed the spacecraft receiver's lock-in range can result in long acquisition times or complete failure of the spacecraft to acquire the signal;
- (d) that some margin should be included to ensure proper acquisition of the Earth station's signal by the spacecraft receiver's phase-locked loop;
- (e) that the spacecraft's receiver may fail to acquire or remain locked to the Earth station's transmitted signal if abrupt phase discontinuities in that signal occur during the acquisition of that signal;

recommends

- (1) that the Earth station transmitter's frequency be adjustable over its specified operating range in increments (step size) of 100 Hz or less;
- (2) that the Earth station transmitter's RF phase continuity be maintained at all times during tuning operations, using frequency sweep rates that are in accordance with Recommendation 401 (2.1.4A) B-1, which will ensure that the spacecraft's receiver remains locked following acquisition.

Earth Stations and Spacecraft

**2.1.8B MINIMUM EARTH STATION TRANSMITTER FREQUENCY RESOLUTION
FOR SPACECRAFT RECEIVER ACQUISITION, CATEGORY B**

The CCSDS,

considering

- (a) that Category B spacecraft receivers typically have phase-locked loop bandwidths ($2 B_{LO}$) in the range of 10 to 100 Hz at their thresholds;
- (b) that for spacecraft receivers having a second order phase-locked-loop with the threshold bandwidths shown in (a), the frequency lock-in range is typically 13 to 133 Hz;
- (c) that steps in Earth station's transmitter frequency which exceed the spacecraft receiver's lock-in range can result in long acquisition times or complete failure of the spacecraft to acquire the signal;
- (d) that some margin should be included to ensure proper acquisition of the Earth station's signal by the spacecraft receiver's phase-locked loop;
- (e) that, with certain Category B missions, it is desirable to continuously tune the Earth-to-space link's transmitter frequency to maintain its value, at the spacecraft, at a single, optimal frequency;
- (f) that the spacecraft's receiver may fail to acquire or remain locked to the Earth station's transmitted signal if abrupt phase discontinuities in that signal occur during the acquisition of that signal;

recommends

- (1) that the Earth station's transmitter frequency be variable over its specified operating range in increments (step size) of 5 Hz or less;
- (2) that the Earth station transmitter's RF phase continuity be maintained at all times during tuning operations, using frequency sweep rates that are in accordance with Recommendation 401 (2.1.4B) B-1, which will ensure that the spacecraft's receiver remains locked following acquisition.

Earth Stations and Spacecraft

RESERVED for RECOMMENDATION 401 (2.2.1)

Earth Stations and Spacecraft

2.2.2 SUBCARRIERS IN TELECOMMAND SYSTEMS

The CCSDS,

considering

- (a) that most space agencies presently utilize either 8 kHz or 16 kHz subcarriers for telecommand transmissions where data rates are less than or equal to 4 kb/s;
- (b) that modulation schemes employing subcarriers reduce the interference to the RF carrier loop resulting from data sidebands;
- (c) that PSK modulation is the most efficient type of digital modulation because of its bit error performance;
- (d) that it is important to limit the occupied bandwidth;

recommends

that CCSDS agencies use a sine wave subcarrier for telecommand, with a frequency of either 8 kHz or 16 kHz, which has been PSK modulated.

Earth Stations and Spacecraft

2.2.3 CHOICE OF PULSE CODE MODULATION (PCM) FORMAT IN TELECOMMAND LINKS

The CCSDS,

considering

- (a) that NRZ-L, -M result in efficient spectrum utilization;
- (b) that present telecommand bit rates are generally less than or equal to 4 kb/s;
- (c) that telecommand data sidebands are separated from the carrier by employing a PSK subcarrier;
- (d) that NRZ-L results in very good signal-to-noise performance;
- (e) that NRZ-M avoids ambiguity errors;

recommends

- (1) that CCSDS agencies use NRZ-L, -M format with PSK subcarriers for telecommand data;
- (2) that due consideration be given to the bit transition density of the telecommand modulation to ensure proper operation of the spacecraft's receiving equipment.

Earth Stations and Spacecraft

2.2.4 LOW-RATE TELECOMMAND SYSTEMS

The CCSDS,

considering

- (a) that many space agencies utilize PCM-PSK modulation for the telecommand links;
- (b) that phase coherency between the PCM signal and the subcarrier facilitates system implementation;
- (c) that subcarrier frequencies of either 8 kHz or 16 kHz are commonly used;
- (d) that many space agencies have developed, or will develop, equipment using telecommand data rates in the range 8-4000 b/s;

recommends

- (1) that CCSDS agencies provide telecommand bit rates in the range $4000/2^n$ b/s, where $n = 0, 1, 2, \dots, 9$;
- (2) that data bit and subcarrier transitions should coincide.

NOTE:

- 1. A 4000 b/s rate should only be used with a 16 kHz subcarrier and care should be taken to ensure that harmful interactions with other signals do not occur.

Earth Stations and Spacecraft

2.2.5 TELECOMMAND SUBCARRIER FREQUENCY STABILITY

The CCSDS,

considering

- (a) that the present use of subcarriers for modulating the Earth-to-space RF links represents a mature technique for both Categories A and B missions and, therefore, is a well settled standard;
- (b) that modifications of this standard imply costly changes to space agencies' networks;

recommends

that CCSDS agencies' Earth stations be designed to provide telecommand subcarriers with characteristics which are equal to or better than:

Maximum Subcarrier Frequency Offset	$\pm (2 \times 10^{-4})f_{sc}$;
Minimum Subcarrier Frequency Stability (1 second);	$\pm 1 \times 10^{-5}$
Minimum Subcarrier Frequency Stability (24 hours).	$\pm 5 \times 10^{-5}$

NOTE:

1. f_{sc} = frequency of telecommand subcarrier.

Earth Stations and Spacecraft

2.2.6 SYMMETRY OF BASEBAND DATA MODULATING WAVEFORMS

The CCSDS,

considering

- (a) that the Earth station's transmitter power should be used as efficiently as possible;
- (b) that undesired spectral components in the Earth station's transmitted signal should be minimized;
- (c) that time-asymmetry in the modulating waveform results in a DC-component;
- (d) that such a DC-component in the modulating waveform results in a data power loss because of AC-coupling in the modulator;
- (e) that, in addition to the power loss, time-asymmetry results in matched filter losses;
- (f) that the above losses should not exceed 0.1 dB;
- (g) that the out-of-band emissions resulting from the time-asymmetry in the modulating waveform can be reduced by additional filtering;

recommends

that, the symmetry of all baseband square wave modulating waveforms should be such that the symbol asymmetry^{3,4} shall not exceed 1%.

NOTE:

- 1. This Recommendation is also filed as Rec. 401 (2.4.8) B-1 for the space-to-Earth link.
- 2. Where Bi-Phase modulation is utilized, larger baseband signal losses, than are permitted by *considering (f)*, may result.
- 3. Definition of: $Symbol\ Asymmetry = \frac{|long\ symbol - short\ symbol|}{long\ symbol + short\ symbol}$.
- 4. Symbol asymmetry shall be measured at 50% of the peak-to-peak amplitude point.

Earth Stations and Spacecraft

2.2.7 MEDIUM-RATE TELECOMMAND SYSTEMS

The CCSDS,

considering

- (a) that most space agencies presently utilize either 8 kHz or 16 kHz subcarriers for telecommand transmissions where data rates are less than or equal to 4kbps;
- (b) that missions in the near future may require higher rates telecommanding capabilities, in the range 8 kbps to 256 kbps;
- (c) that the possibility of simultaneous ranging, telecommand transmission and telemetry reception can result in optimal utilization of the Earth station coverage time;
- (d) that ranging requires that a distinct carrier component be present in the up- and down-link signals;
- (e) that subcarrier modulation techniques require substantially more spectrum compared to other modulation techniques;
- (f) that the use of PCM/PM/Bi-phase modulation is justified when a distinct carrier component is required and only for bit rates below 2 Mbps;

recommends

- (1) that CCSDS agencies use PCM/PM/Bi-phase modulation direct on the carrier for medium rate telecommand data transmission;
- (2) that CCSDS agencies provide medium telecommand bit rates in the range¹ $R = 4000 \cdot 2^n$ where $n=1 \dots, 6$.

¹ For the purpose of this recommendation, the bit rates are defined prior to Bi-phase encoding.

Earth Stations and Spacecraft

2.2.8 SUPPRESSED CARRIER TELECOMMAND SYSTEMS

The CCSDS,

considering

- (a) that missions in the near future may require higher rate telecommanding capabilities, up to 1.024 Mbps;
- (b) that it is important to limit the occupied bandwidth at high telecommand rates to reduce out-of-band interference;
- (c) that BPSK modulated directly on the carrier requires less bandwidth than PCM/PM/Bi-phase and subcarrier modulation techniques;
- (d) that some currently used two-way ranging systems are not compatible with suppressed carrier modulations;
- (e) that the carrier can be recovered from BPSK signals for Doppler measurements using suppressed carrier tracking techniques such as the Costas loop;
- (f) that some missions do not require ranging nor do they require a distinct carrier component for Doppler measurement;

noting

that there are residual carrier CCSDS recommendations for simultaneous telecommand and ranging;¹

recommends

- (1) that when a residual carrier system does not satisfy the mission requirements, CCSDS agencies use BPSK modulation for telecommand data transmissions up to 1.024 Mbps;
- (2) that the telecommand bit rates for BPSK modulation be selected in the range $R = 1000 * 2^n$ bps where $n = 0, \dots, 10$.

¹See CCSDS Recommendations 401 (2.2.2) B-1 to 401 (2.2.7) B-1.

Earth Stations and Spacecraft

2.3.1 RESIDUAL CARRIERS FOR LOW RATE TELEMETRY, SPACE-TO-EARTH LINKS

The CCSDS,

considering

- (a) that many space agencies own and/or operate Earth stations for communication with spacecraft in which they have substantial investments;
- (b) that these Earth stations contain receiving equipment employing phase-locked loops;
- (c) that conventional phase-locked loop receivers require a residual carrier component to operate properly;
- (d) that most space agencies use autotrack systems for Category A missions, which need a residual carrier;

recommends

that CCSDS agencies retain residual carrier receiving systems in their Earth stations for use with missions having low rate telemetry requirements.

Earth Stations and Spacecraft

2.3.2 USE OF SUPPRESSED CARRIER MODULATIONS (BPSK/QPSK) FOR MEDIUM RATE TELEMETRY SPACE-TO-EARTH LINKS

The CCSDS,

considering

- (a) that present technology makes the implementation of suppressed carrier modulation systems practicable;
- (b) that a comparison of carrier signal-to-noise ratios in a conventional residual carrier phase-locked loop with those in a suppressed carrier loop shows that the latter provides a substantial advantage over the former, frequently exceeding 10 dB;
- (c) that a comparison of data symbol errors occurring in a conventional residual carrier phase-locked loop system with those occurring in a suppressed carrier loop system shows that the latter's performance is no worse, and frequently is better, than that of the former;
- (d) that suppressed carrier systems lend themselves to compliance with PFD limits on the Earth's surface more readily than do residual carrier systems;
- (e) that recommendation 2.4.17A defines recommended bandwidth efficient modulation formats for high symbol rate (> 2 Ms/s) space-to-Earth transmissions from Category A missions in space research service bands;
- (f) that recommendation 2.4.17B defines recommended bandwidth efficient modulation formats for high symbol rate (> 2 Ms/s) space-to-Earth transmissions from Category B missions in space research service bands;
- (g) that recommendation 2.4.18 defines recommended bandwidth efficient modulation formats for high symbol rate (> 2 Ms/s) space-to-Earth transmissions from missions in Earth Exploration Satellite Service;
- (h) that short periodic data patterns can result in zero power at the carrier frequency;

recommends

- (1) that CCSDS agencies utilize suppressed carrier modulation formats such as BPSK, QPSK, or OQPSK^{1,2} for medium rate (≤ 2 Ms/s) space-to-Earth communications whenever possible and in any case when a residual carrier system would exceed the PFD limits on the Earth's surface;
- (2) that CCSDS agencies refer to recommendations 2.4.17A, 2.4.17B, and 2.4.18 for recommended modulation formats for high symbol rate (> 2 Ms/s) transmissions;
- (3) that CCSDS agencies use a data randomizer as specified in the CCSDS Blue Book, *TM Synchronization and Channel Coding*, CCSDS 131.0-B-1 (or latest edition).

¹ Subject to the constraints of SFCG recommendations 21-2R2 and 23-1 or latest version.

² See also recommendation CCSDS 401.0 (3.3.3A) B-2.

Earth Stations and Spacecraft

2.3.3A EARTH STATION RECEIVER ACQUISITION FREQUENCY SWEEP RANGE, CATEGORY A

The CCSDS,

considering

- (a) that the space-to-Earth link may be operated in either a coherent turnaround mode, or in a one-way mode;
- (b) that for the coherent turnaround mode, the Doppler frequency shift induced on both the Earth-to-space and the space-to-Earth links is the major factor to be considered in selecting the frequency acquisition range;
- (c) that for the one-way mode, both the Doppler frequency shift induced on the space-to-Earth link and the frequency stability of the spacecraft's oscillator are the major factors to be considered in selecting the frequency acquisition range;
- (d) that the maximum rate of change of distance between the Earth station and Category A spacecraft can reach values of up to 10 km/s;
- (e) that the minimum frequency stability found in Category A spacecraft reference frequency oscillators is about $2 \times 10^{-5} = 20$ ppm;
- (f) that the Doppler frequency shift can usually be predicted to an accuracy of ± 1 kHz;
- (g) that digital receivers can use FFT algorithms for carrier acquisition rather than frequency sweeping;

recommends

- (1) that CCSDS agencies' Earth station receivers be capable of frequency acquisition ranges of at least:
 - ± 150 kHz at 2 GHz¹
 - ± 600 kHz at 8 GHz¹
 - ± 1800 kHz at 26 GHz;¹
- (2) that CCSDS agencies provide a minimum acquisition range that is consistent with their ability to predict the Doppler frequency acquisition.

¹ These numbers cover the worst case between two-way and one-way modes with spacecraft oscillator stability included in the latter.

Earth Stations and Spacecraft

2.3.3B EARTH STATION RECEIVER ACQUISITION FREQUENCY SWEEP RANGE, CATEGORY B

The CCSDS,

considering

- (a) that the space-to-Earth link may be operated in either a coherent turnaround mode, or in a one-way mode;
- (b) that in the coherent turnaround mode, the Doppler frequency shift induced on both the Earth-to-space and the space-to-Earth links is the major factor to be considered in selecting the frequency acquisition range;
- (c) that the effect on the radio link, resulting from variation in the columnar charged-particle content, is generally negligible;
- (d) that the maximum rate of change of distance between the Earth station and Category B spacecraft can reach values of up to 35 km/s;
- (e) that the minimum frequency stability found in Category B spacecraft reference frequency oscillators is about $1 \times 10^{-6} = 1$ ppm;
- (f) that the Doppler frequency shift can usually be predicted to an accuracy of ± 1 kHz;
- (g) that digital receivers can use FFT algorithms for carrier acquisition rather than frequency sweeping;

recommends

- (1) that CCSDS agencies' Earth station receivers be able to support frequency acquisition ranges of at least:
 - ± 300 kHz at 2 GHz¹
 - ± 1 MHz at 8 GHz¹
 - ± 4 MHz at 32 GHz;¹
- (2) that CCSDS agencies provide a minimum acquisition range that is consistent with their ability to predict the Doppler frequency shift.

¹ Maximum acquisition range applies to one-way (non-coherent) mode; coherent turnaround mode will approximately double maximum acquisition range.

Earth Stations and Spacecraft

2.3.4A EARTH STATION RECEIVER ACQUISITION FREQUENCY SWEEP RATE, CATEGORY A

The CCSDS,

considering

- (a) that the space-to-Earth link may be operated in either a coherent turnaround mode or in a one-way mode;
- (b) that in the coherent turnaround mode, the Doppler frequency rates induced on both the Earth-to-space and the space-to-Earth links are the major factors to be considered in selecting the Earth station receiver's frequency sweep rate;
- (c) that in the one-way mode, the Doppler frequency rate on the space-to-Earth link and the Earth station receiver's phase locked loop bandwidth ($2 B_{LO}$), with its resulting maximum permissible input frequency variation, are the major factors to be considered in selecting the sweep rate;
- (d) that the rate-of-change of velocity¹ between the Earth station and Category A spacecraft can reach values up to 380 m/s^2 , which results in frequency variation rates of approximately 3 kHz/s at 2 GHz, 10 kHz/s at 8 GHz, and 34 kHz/s at 26 GHz in the one-way mode (or 6 kHz/s, 20 kHz/s, and 68 kHz/s respectively in the coherent turnaround mode);
- (e) that the Earth station's receivers generally have phase locked loop bandwidths ($2 B_{LO}$) in the range of 30 Hz to 2 kHz at their threshold;
- (f) that, for an acquisition probability of 0.9, the maximum permissible rate of input frequency variation for this type of Earth station receiver is between 100 Hz/s and 400 kHz/s at its threshold;
- (g) that the Earth station receiver's frequency sweep rate plus the spacecraft's Doppler frequency rate must not exceed the receiver's ability to achieve phase-locked operation;
- (h) that the acquisition time should be kept to a minimum for each mission phase;

recommends

that CCSDS agencies' Earth station receivers operating in the 2, 8, and 26 GHz bands should have a minimum frequency sweep rate not exceeding 100 Hz/s and a maximum frequency sweep rate of at least 200 kHz/s.

¹ For circular orbits the Doppler rate is negative.

Earth Stations and Spacecraft

2.3.4B EARTH STATION RECEIVER ACQUISITION FREQUENCY SWEEP RATE, CATEGORY B

The CCSDS,

considering

- (a) that the space-to-Earth link may be operated in either a coherent turnaround mode, or in a one-way mode;
- (b) that in the coherent turnaround mode, the Doppler frequency rates induced on both the Earth-to-space and the space-to-Earth links are the major factors to be considered in selecting the Earth station receiver's frequency sweep rate;
- (c) that in the one-way mode, the Doppler rate on the space-to-Earth link and the Earth station receiver's phase-locked loop bandwidth ($2 B_{LO}$), with its resulting maximum permissible input frequency variation, are the major factors to be considered in selecting the sweep rate;
- (d) that the rate of change of velocity between the Earth station and category B spacecraft can reach values up to 10 m/s^2 ;
- (e) that the Earth station's receivers have phase-locked loop bandwidths ($2 B_{LO}$) in the range of 1 Hz to 1 kHz at their thresholds;
- (f) that typical Earth station receivers, operating in the 2, 8, and 32 GHz bands, allow a maximum permissible rate of input frequency variation of between 1 Hz/s and 10 kHz/s;
- (g) that the receiver's frequency sweep rate, plus the orbital Doppler frequency rate, must not exceed the Earth station receiver's ability to achieve phase-locked operation;
- (h) that the acquisition time should be kept to a minimum for each mission phase;
- (i) that a lower limit for the signal-to-noise ratio in the Earth station receiver's phase-locked loop is approximately 8.5 dB;

recommends

that CCSDS agencies' Earth station receivers, operating in the 2, 8, and 32 GHz bands, should have a minimum sweep rate not exceeding 1 Hz/s and a maximum sweep rate of at least 10 kHz/s.

Earth Stations and Spacecraft

2.3.5 POLARIZATION OF SPACE-TO-EARTH LINKS

The CCSDS,

considering

- (a) that a linear electric field polarization on links from spacecraft, having nearly omnidirectional antenna patterns, may vary considerably with aspect angle;¹
- (b) that the aspect angle of a near-Earth orbiting satellite varies greatly during a pass;
- (c) that for satellites having a stable linear polarization in the direction of the Earth station (e.g., geostationary satellites with suitable attitude stabilization or satellites using tracking antennas), the propagation effects such as Faraday rotation may cause changes in the received polarization at lower carrier frequencies;
- (d) that many Earth stations are equipped with polarization diversity receivers;
- (e) that many existing spacecraft TTC antenna designs provide circular polarization;

recommends

- (1) that CCSDS agencies utilize LCP or RCP polarization for satellite TTC space-to-Earth links unless sharing of equipment with payload functions requires a different approach;
- (2) that automatic polarization tracking should be used for reception of satellite signals wherever possible;
- (3) that when using linear polarization, polarization diversity reception should be used to meet the required system time constants² at Earth stations used for Category A missions.

¹ A satellite in a LEO orbit that has a linear polarization will not appear to have a constant polarization orientation to a receiving ground station, except under very specific conditions. Circular polarization will not have this problem.

² The rate of change of polarization due to the satellite motion is small, less than 180 degrees over the pass duration.. When polarization diversity reception is used, the equipment switching time constants must be set to a sufficiently long time so that the equipment does not switch back and forth between horizontal and vertical while trying to acquire or maintain the signal.

Earth Stations and Spacecraft

2.3.6 RELATIONSHIP OF MODULATOR INPUT VOLTAGE TO RESULTANT RF CARRIER PHASE SHIFT

The CCSDS,

considering

that a clear relationship between the modulating signal and the RF carrier's phase is desirable to avoid unnecessary ambiguity problems;

recommends

that a positive-going voltage at the modulator input should result in an advance of the phase of the radio frequency signal.

NOTE:

1. This Recommendation is also filed as Rec. 401 (2.1.5) B-1.

Earth Stations and Spacecraft

2.3.7 EARTH STATION OSCILLATOR REFERENCE FREQUENCY STABILITY

The CCSDS,

considering

- (a) that most of the space agencies use a reference frequency standard to which the Earth station's receiver and transmitter local oscillators are locked;
- (b) that the short term frequency stability of the local oscillator substantially determines the range rate measurement's accuracy for Category A missions;
- (c) that the long term frequency stability of the local oscillator substantially determines the range rate measurement's accuracy for Category B missions;
- (d) that it is desirable for many missions to determine range rate with an accuracy of 1 mm/s or better;
- (e) that the oscillator's frequency shall be sufficiently stable such that its effect upon the range rate measurement's error shall be significantly less than 1 mm/s;
- (f) that, in addition to the foregoing, the long term stability of the local oscillator is also determined by the drift permitted in the Earth station's clock which should not exceed 10 microseconds per month;

recommends

- (1) that the short term frequency stability (Allan Variance) shall be better than $\pm 5 \times 10^{-13}$ for time intervals between 0.2 s and 100 s;
- (2) that for Category B missions and for timekeeping, the long term frequency stability shall be better than $\pm 2 \times 10^{-12}$ for any time interval greater than 100 s.

Earth Stations and Spacecraft

**2.3.8 RF CARRIER SUPPRESSION ON SPACE-TO-EARTH LINKS FOR
RESIDUAL CARRIER SYSTEMS**

The CCSDS,

considering

- (a) that high modulation indices may make a residual carrier difficult to detect with a conventional phase-locked loop receiver;
- (b) that, for sine wave modulation, the carrier suppression should not exceed 10 dB as otherwise the recoverable power in the data channel decreases;
- (c) that, for square wave modulation, increasing the carrier suppression above 10 dB can result in a performance improvement in the data channel provided that the additional demodulation losses, resulting from the reduced carrier power, are less than the resulting data power increase;
- (d) that, where an error-detecting/correcting code is used on the data channel, a carrier tracking loop signal-to-noise ratio below 15 dB will result in demodulation losses which exceed the data power increase obtained by using a carrier suppression above 10 dB;

recommends

- (1) that, for sine wave modulation, the carrier suppression should not exceed 10 dB;
- (2) that, for square wave modulation, the carrier suppression may exceed 10 dB provided that the carrier tracking loop's signal-to-noise ratio remains above 15 dB.

Earth Stations and Spacecraft

RESERVED for RECOMMENDATION 401 (2.4.1)

Earth Stations and Spacecraft

2.4.2 PULSE CODE MODULATION (PCM) FORMAT FOR SUPPRESSED CARRIER SYSTEMS

The CCSDS,

considering

- (a) that interaction between data sidebands and their RF carrier causes undesirable performance degradation;
- (b) that suppressed carrier modulation schemes eliminate interaction between data sidebands and the RF carrier;
- (c) that the necessary bandwidth for a suppressed carrier system with NRZ modulation is less than for a residual carrier system using Manchester or subcarrier modulation schemes;
- (d) that the lack of a carrier reference at the demodulator results in a phase ambiguity in the data that depends on the order of the modulation;
- (e) that this phase ambiguity is unacceptable and must be removed either by using synchronization markers, or by using a modulation that is insensitive to polarity as recommended in 401 (2.4.11);
- (f) that Differential NRZ (DNRZ) format is insensitive to polarity;
- (g) that DNRZ conversion inherently produces two bit errors at the converter output for every single bit error at the converter input, but the use of synchronization markers can result in the loss of entire frames;
- (h) that placing the differential encoder before the convolutional encoder mitigates the propagation of errors;
- (i) that some CCSDS member agencies use suppressed carrier modulation with DNRZ format in their relay satellites to reduce the necessary bandwidth while preventing data-carrier interaction;
- (j) that either NRZ-M or NRZ-S is an acceptable DNRZ format;
- (k) that NRZ-M is currently in use;

recommends

- (1) that suppressed carrier modulation schemes select NRZ-M format in case synchronization markers are not used and select NRZ-L format otherwise, as recommended in 401 (2.4.11);
- (2) that in convolutionally encoded systems requiring conversion between NRZ-L and NRZ-M, the conversion from NRZ-L take place before the input to the convolutional encoder, and the conversion from NRZ-M to NRZ-L take place after the output from the convolutional decoder in order to maximize performance.

Earth Stations and Spacecraft

2.4.3 SUBCARRIERS IN LOW BIT RATE RESIDUAL CARRIER TELEMETRY SYSTEMS

The CCSDS,

considering

- (a) that at low bit rates, interaction between data sidebands and the residual RF carrier causes a performance degradation;
- (b) that subcarrier modulation schemes eliminate interaction between data sidebands and the residual RF carrier but are bandwidth-inefficient;
- (c) that PSK modulation is a very efficient type of digital modulation because of its bit error performance;
- (d) that for Category A missions, it is more important to limit the occupied bandwidth while for Category B missions, it is more important to minimize the susceptibility to in-band interference.

recommends

- (1) that CCSDS agencies limit the use of subcarriers to cases justified by technical reasons, i.e., low bit rate transmissions or radio science;
- (2) that CCSDS agencies use PSK modulation for these subcarriers;
- (3) that for Category A missions telemetry transmission, CCSDS agencies use sine wave subcarriers;
- (4) that for Category B missions telemetry transmission, CCSDS agencies use square wave subcarriers.

Earth Stations and Spacecraft

2.4.4 PSK MODULATION FOR TELEMETRY SUBCARRIERS

This recommendation has been deleted (CCSDS resolution MC-E03-01).

Earth Stations and Spacecraft

2.4.5 TELEMETRY SUBCARRIER WAVEFORMS

This recommendation has been deleted (CCSDS resolution MC-E03-01).

Earth Stations and Spacecraft

2.4.6 TELEMETRY SUBCARRIER¹ FREQUENCY STABILITY IN RESIDUAL CARRIER TELEMETRY SYSTEMS

The CCSDS,
considering

- (a) that the present use of subcarriers for modulating the space-to-Earth RF links as in CCSDS Recommendation 2.4.7 represents a mature technique for both Categories A and B missions and, therefore, is a well settled standard;
- (b) that the subcarrier frequency-to-symbol rate ratio is an integer value as in CCSDS Recommendations 2.4.14A and 2.4.14B;
- (c) that transponders can derive the subcarrier frequency from an oscillator or an NCO, if using digital processing;
- (d) that the resolution of the subcarrier frequency NCO, if used, determines the subcarrier frequency settability and may be as large as 1 Hz;
- (e) that the short term subcarrier frequency stability should be less than the ground station receiver subcarrier tracking loop bandwidth;
- (f) that ground station receivers can have subcarrier tracking loop bandwidths as low as 100 mHz using digital processing;
- (g) that the minimum long term frequency stability found in Category A spacecraft reference frequency oscillators is about ± 20 ppm;
- (h) that the minimum long term frequency stability found in Category B spacecraft reference frequency oscillators is about ± 1 ppm;

recommends

that spacecraft radio frequency subsystems generating telemetry subcarriers be designed with characteristics equal to or better than:

Maximum Subcarrier Frequency Offset ²	± 200 ppm;
Minimum Subcarrier Frequency Stability (short term); ³	$\pm 1 \times 10^{-6}$
Minimum Subcarrier Frequency Stability (long term). ⁴	$\pm 2 \times 10^{-5}$

¹ For the purpose of this recommendation, subcarrier includes but is not limited to Bi- ϕ waveforms. In this case, the subcarrier-to-symbol rate ratio is one and the subcarrier is a squarewave.

² For Category B missions with TCXO oscillators, the largest contribution is given by the number of quantization bits of the NCO. This is a deterministic offset that can be compensated for.

³ Short term time intervals are less than or equal, 100 times the subcarrier's waveform period.

⁴ Stability over 5 minutes.

Earth Stations and Spacecraft

2.4.7 CHOICE OF PCM WAVEFORMS IN RESIDUAL CARRIER TELEMETRY SYSTEMS

The CCSDS,

considering

- (a) that NRZ waveforms rely entirely on data transitions for symbol clock recovery, and this recovery becomes problematical unless an adequate transition density can be guaranteed;
- (b) that due to the presence of the mid-bit transitions, Bi- ϕ waveforms provide better properties for bridging extended periods of identical symbols after initial acquisition;
- (c) that convolutionally encoded data have sufficient data transitions to ensure symbol clock recovery in accordance with the CCSDS recommended standards;
- (d) that with coherent PSK subcarrier modulation, it is possible by adequate hardware implementation to bridge extended periods of identical symbols even when NRZ waveforms are used;
- (e) that NRZ waveforms without a subcarrier have a non-zero spectral density at the RF carrier;
- (f) that coherent PSK subcarrier modulated by NRZ data and using an integer subcarrier frequency to symbol rate ratio, as well as Bi- ϕ waveforms, have zero spectral density at the RF carrier;
- (g) that the ambiguity which is peculiar to NRZ-L and Bi- ϕ waveforms can be removed by adequate steps;
- (h) that use of NRZ-M and NRZ-S waveforms results in errors occurring in pairs;
- (i) that it is desirable to prevent unnecessary decoder node switching by frame synchronization prior to convolutional decoding (particularly true for concatenated convolutional Reed-Solomon coding);
- (j) that to promote standardization, it is undesirable to increase the number of options unnecessarily, and that for any proposed scheme, those already implemented by space agencies should be considered first;

recommends

- (1) that for modulation schemes which use a subcarrier, the subcarrier to bit rate ratio should be an integer;
- (2) that in cases where a subcarrier is employed, NRZ-L should be used;
- (3) that for direct modulation schemes having a residual carrier, only Bi- ϕ waveforms should be used;
- (4) that ambiguity resolution should be provided.

Earth Stations and Spacecraft

2.4.8 MAXIMUM PERMISSIBLE SYMBOL ASYMMETRY FOR DIGITAL SIGNALS AT THE INPUT TO THE RF MODULATOR

The CCSDS,

considering

- (a) that symbol asymmetry^{1,2} results in unwanted spectral components in the spacecraft's transmitted RF signal;
- (b) that such unwanted spectral components can cause harmful interference to other users of the frequency band;
- (c) that for a wide range of symbol³ rates, current technology permits control of the symbol asymmetry such that these components can be reduced to a level of -60 dBc or lower;
- (d) that, in addition to unwanted spectral components, symbol asymmetry results in data power and matched filter losses which should be minimized;
- (e) that rise and fall time of digital circuits sets a limit on achievable symbol asymmetry;

recommends

that the symbol asymmetry^{1,2} shall not exceed 0.2 %.

NOTES:

- 1. Definition of: $Symbol\ Asymmetry = \frac{|long\ symbol - short\ symbol|}{long\ symbol + short\ symbol}$.
- 2. Symbol asymmetry shall be measured at 50% of the peak-to-peak amplitude point.
- 3. A symbol is not unambiguously defined in the literature. For purposes of this Recommendation, a symbol shall be equivalent to:
 - a bit or an encoded bit or a chip in the case of NRZ waveforms;
 - half a bit or half an encoded bit or half an encoded chip in the case of Bi- ϕ waveforms;
 - half of the clock cycle for a squarewave subcarrier.

Earth Stations and Spacecraft

2.4.9 MINIMUM MODULATED SYMBOL TRANSITION DENSITY ON THE SPACE-TO-EARTH LINK

The CCSDS,

considering

- (a) that symbol clock recovery systems usually extract the clock's frequency from the received symbol transitions;
- (b) that a large imbalance between ones and zeros in the data stream could result in a bit-error-rate degradation in the symbol detection process;
- (c) that NRZ waveforms are widely used in standard modulation systems;
- (d) that NRZ waveforms require sufficient symbol transitions for symbol clock recovery;
- (e) that the tracking system loop bandwidth is usually less than, or equal to, one percent of the symbol rate;
- (f) that, for Category A, the specified degradation in bit error rate, due to symbol sync error, is usually less than 0.3 dB;
- (g) that, for Category B, the specified degradation in bit error rate, due to symbol sync error, is usually less than 0.1 dB;
- (h) that symbol transitions are not a sufficient condition to ensure a stable lock condition;
- (i) that the use of a pseudo-randomizer will improve the stability of lock conditions;

recommends

- (1) that the maximum string of either ones or zeros be limited to 64 bits;
- (2) that, for Category A, a minimum of 125 transitions occur in any sequence of 1000 consecutive symbols;
- (3) that, for Category B, a minimum of 275 transitions occur in any sequence of 1000 consecutive symbols;
- (4) that both Category A and B missions follow the guidance of CCSDS Recommended Standard *TM Synchronization and Channel Coding*, CCSDS 131-B-1, September 2003, or later issue with respect to the use of a pseudo-randomizer.

Earth Stations and Spacecraft

2.4.10 CHANNEL INPUT AND CODING CONVENTIONS FOR QPSK SYSTEMS

The CCSDS,

considering

- (a) that a clear relation between digital information and the resulting RF carrier phase is necessary to reconstruct the digital data stream following reception and demodulation;
- (b) that the digital data format will conform to the CCSDS Recommendation for *Packet Telemetry*;
- (c) that some communications systems with high data rate transmission requirements use QPSK modulation;
- (d) that the phase states representing each of the possible bit-pair values should be judiciously chosen so that a phase error of 90 degrees can cause an error in no more than one bit;
- (e) that it should be possible to have two logically independent channels;
- (f) that in the case of a single data stream the odd and even bits should be forwarded to two independent channels;

recommends

- (1) that the serial input digital data stream to QPSK systems be divided so that even bits (i.e., bits $2i$ where $i = 0, 1, 2, \dots, (N/2) - 1$) are modulated on the I-channel and odd bits (i.e., bits $2i + 1$) are modulated on the Q-channel (see also the bit numbering convention in figure 2.4.10-1);
- (2) that carrier phase states have the following meanings as given in figure 2.4.10-2:
 - 45 degrees represents a "00" (IQ) bit pair,
 - 135 degrees represents a "10" (IQ) bit pair,
 - 225 degrees represents a "11" (IQ) bit pair,
 - 315 degrees represents a "01" (IQ) bit pair.

The following convention is used to identify each bit in an N -bit field. The first bit in the field to be transmitted (i.e., the most left justified when drawing a figure) is defined to be 'Bit 0', the following bit is defined to be 'Bit 1', and so on up to 'Bit $N-1$ '. When the field is used to express a binary value (such as a counter), the Most Significant Bit (MSB) shall be the first transmitted bit of the field, i.e., 'Bit 0' (see figure 2.4.10-1).

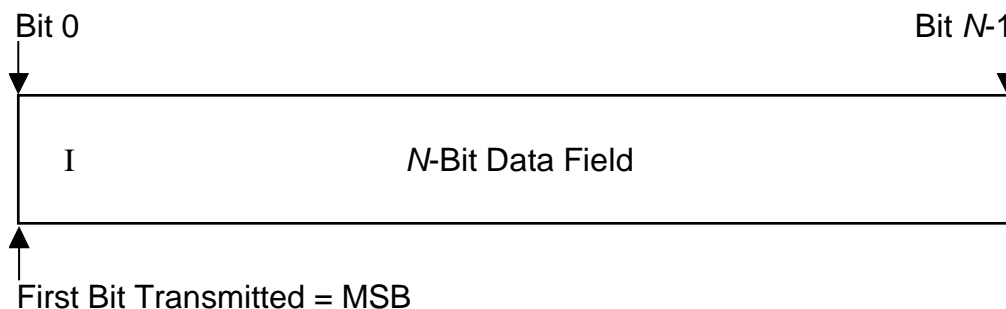

Figure 2.4.10-1: Bit Numbering Convention

Earth Stations and Spacecraft

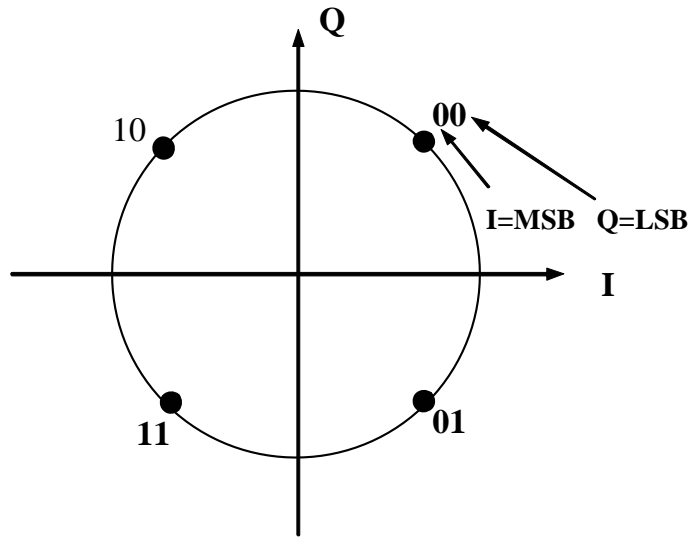

Figure 2.4.10-2: Constellation Mapping

Earth Stations and Spacecraft

2.4.11 PHASE-AMBIGUITY RESOLUTION FOR QPSK/OQPSK MODULATION SYSTEMS USING A SINGLE DATA SOURCE¹

The CCSDS,

considering

- (a) that resolution of phase ambiguities in the Earth station's receiver is an inherent problem with systems using coherent Quaternary Phase-Shift-Keying (QPSK) and Offset QPSK (OQPSK) modulation;
- (b) that bit mapping conventions for QPSK systems are unambiguously defined in CCSDS Recommendation 401 (2.4.10);
- (c) that the phase ambiguity results from the lack of transmission of reference phase information, thus making it impossible for the receiver's carrier recovery circuitry to select the correct reference phase from the four possible stable lock points (Table 2.4.11-1);
- (d) that when convolutional encoding is used, some Agencies perform node synchronization based on the encoded frame synchronization marker before the convolutional decoder, while some Agencies use the metric growth in the convolutional decoder;
- (e) that the phase-ambiguity can be resolved by using the techniques listed in figure 2.4.11-1;
- (f) that the several methods for resolving the phase ambiguity depicted in figure 2.4.11-1 are evaluated in Table 2.4.11-2;
- (g) that most space agencies currently employ differential data formatting and synchronization (sync) markers for framed data transmission;
- (h) that any of the four possible phase states result in an unambiguously identifiable unique word pattern according to Table 2.4.11-1 which can be used to resolve the phase ambiguity;
- (i) that the sync markers already existing in the framed data transmission can be used as the unique words for resolving the phase ambiguity;
- (j) that even though a single convolutional encoder can be used prior to the I/Q split in the transmitter, there is a penalty (in terms of higher E_b/N_0) to allowing the single decoder to resolve the phase ambiguity;

recommends

- (1) that, if the capability exists in the ground stations, sync marker(s) shall be used to resolve the phase ambiguity;

NOTE:

- 1. Such systems employ a single, serial data stream and the bit mapping ambiguity is resolved in accordance with CCSDS Recommendation 401 (2.4.10) B-1.

Earth Stations and Spacecraft

2.4.11 PHASE-AMBIGUITY RESOLUTION FOR QPSK/OQPSK MODULATION SYSTEMS USING A SINGLE DATA SOURCE (Continued)

- (2) that when sync marker(s) are used with coded systems, the synchronization shall be performed prior to convolutional decoding;
- (3) that the differential data formatting techniques defined in CCSDS recommendation 401 (2.4.2) shall be used when the sync marker is not used;
- (4) that when differential data formatting is used with coded systems, the I and Q channels shall be encoded (and therefore decoded) independently with the differential data formatting performed prior to convolutional encoding.

Earth Stations and Spacecraft

2.4.11 PHASE-AMBIGUITY RESOLUTION FOR QPSK/OQPSK MODULATION SYSTEMS USING A SINGLE DATA SOURCE (Continued)

ANNEX TO RECOMMENDATION

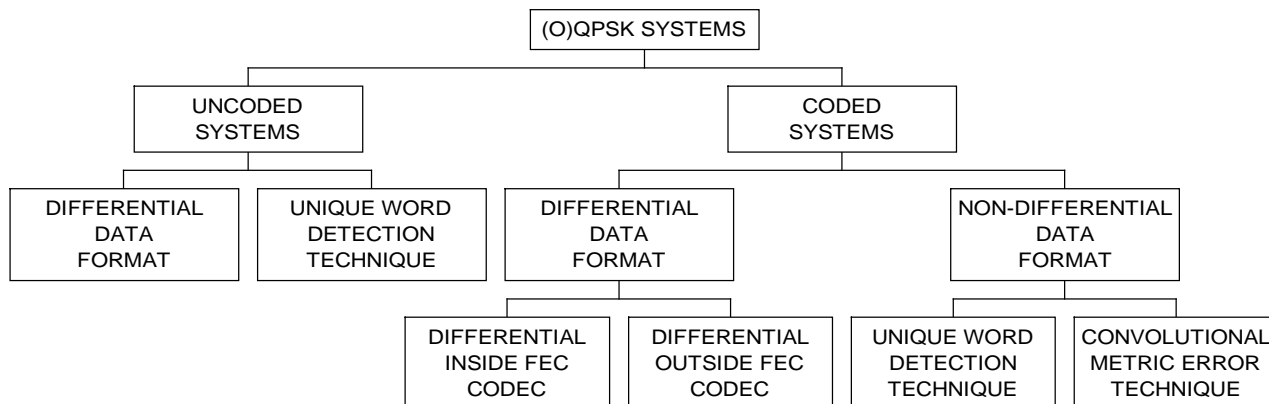

Figure 2.4.11-1: List of Phase-Ambiguity Resolution Techniques

LEGEND:

FEC : Forward-Error-Correction
CODEC: Encoder and Decoder Pair

Earth Stations and Spacecraft

2.4.11 PHASE-AMBIGUITY RESOLUTION FOR QPSK/OQPSK MODULATION SYSTEMS USING A SINGLE DATA SOURCE (Continued)

ANNEX TO RECOMMENDATION (Continued)

TABLE 2.4.11-1: RELATIONSHIPS BETWEEN THE TRANSMITTED AND RECEIVED DATA

CARRIER PHASE ERROR (DEGREES)	RECEIVED DATA	
	I_R	Q_R
0	I_T	Q_T
90	$-Q_T$	I_T
180	$-I_T$	$-Q_T$
270	Q_T	$-I_T$

NOTE:

1. The negative sign indicates the complement of the data.

2.4.11 PHASE-AMBIGUITY RESOLUTION FOR QPSK/OQPSK MODULATION SYSTEMS USING A SINGLE DATA SOURCE (Continued)

ANNEX TO RECOMMENDATION (Continued)

TABLE 2.4.11-2: SUMMARY OF THE SALIENT FEATURES OF THE PREFERRED TECHNIQUES

AVAILABLE TECHNIQUES	BIT ERROR RATE (BER) DEGRADATION	ADVANTAGES & DISADVANTAGE
UNIQUE WORD DETECTION	NONE	- INCREASE EARTH STATION COMPLEXITY
DIFFERENTIAL DATA FORMATTING WITHOUT FORWARD-ERROR-CORRECTION (FEC)	INCREASES BY APPROXIMATELY A FACTOR OF TWO	- SIMPLE TO IMPLEMENT - CAN CAUSE DEGRADATION IN THE DETECTION OF THE TRANSMITTED SYNC MARKERS
DIFFERENTIAL DATA FORMATTING INSIDE THE FEC ENCODER AND DECODER PAIR (CODEC)	ABOUT 3 dB FOR CONVOLUTIONAL CODE WITH $R = \frac{1}{2}$, $K = 7$	- PROVIDES QUICK PHASE AMBIGUITY RESOLUTION - REQUIRES OVERPOWERED LINK
DIFFERENTIAL DATA FORMATTING OUTSIDE THE FEC CODEC	SMALL	- REQUIRES DIFFERENTIAL DECODERS AT THE STATION

Earth Stations and Spacecraft

2.4.12A MAXIMUM PERMISSIBLE PHASE AND AMPLITUDE IMBALANCES FOR SUPPRESSED CARRIER (BPSK/(O)QPSK/GMSK) RF MODULATORS FOR SPACE-TO-EARTH LINKS, CATEGORY A

The CCSDS,

considering

- (a) that suppressed carrier modulation (PSK) is recommended by CCSDS [401 (2.3.2) B-1] for spacecraft telemetry transmissions in the 2 and 8 GHz bands when residual carrier modulation would exceed PFD limits on the Earth's surface;
- (b) that Filtered OQPSK and GMSK modulations are recommended by CCSDS [401 (2.4.17A) B-2] for high rate telemetry in the 2 and 8 GHz Category A bands and by CCSDS [401 (2.4.18) B-2] in the 8 GHz EESS band;
- (c) that, for a balanced quadrature modulation, the phase and amplitude imbalances in the modulated RF carrier as well as the phase imbalance between channels contribute to the generation of cross-talk between channels through either a failure of maintaining the inter-channel orthogonality or an imperfect carrier tracking, which can be detrimental to the system performance;
- (d) that a phase imbalance of less than 5 degrees and an amplitude imbalance of less than 0.5 dB should result in acceptable performance degradations for near-Earth missions;
- (e) that the maximum allowable AM/PM slope for the non-linear amplifier is typically less than 3.5°/dB;

recommends

that the modulator's phase imbalance shall not exceed 5 degrees and the amplitude imbalance shall not exceed 0.5 dB between the constellation points in a suppressed carrier RF modulation system using BPSK, (O)QPSK, Filtered OQPSK, or GMSK ($BT_s = 0.25$).

Earth Stations and Spacecraft

**2.4.12B MAXIMUM PERMISSIBLE PHASE AND AMPLITUDE IMBALANCES FOR
SUPPRESSED CARRIER (BPSK/(O)QPSK/GMSK) RF MODULATORS FOR
SPACE-TO-EARTH LINKS, CATEGORY B**

The CCSDS,

considering

- (a) that suppressed carrier modulation (PSK) is recommended by CCSDS [401 (2.3.2) B-2] for spacecraft telemetry transmissions in the 2 and 8 GHz Category B bands;
- (b) that Gaussian Minimum Shift Keying with $BT_S=0.5$ is recommended by CCSDS [401 (2.4.17B) B-2] for high rate telemetry in the 2 and 8 GHz Category B bands;
- (c) that, for a balanced quadrature modulation of which the data rate and the power are the same for both In-phase (I) and Quadrature (Q) channels, the phase imbalance between channels caused by a deviation from the ideal 90-degree separation occurs when the phase shifter at the transmitter and/or the receiver is no longer operated in the linear region;
- (e) that, for a balanced quadrature modulation, the phase and amplitude imbalances in the modulated RF carrier as well as the phase imbalance between channels contribute to the generation of cross-talk between channels through either a failure of maintaining the inter-channel orthogonality or an imperfect carrier tracking, which can be detrimental to the system performance;

recommends

that the modulator's phase imbalance shall not exceed 5 degrees and the amplitude imbalance shall not exceed 0.5 dB between the constellation points for suppressed carrier systems using BPSK, (O)QPSK, or GMSK ($BT_S=0.5$).

Earth Stations and Spacecraft

**2.4.13B MAXIMUM PERMISSIBLE PHASE AND AMPLITUDE IMBALANCES FOR
SPACECRAFT SUBCARRIER MODULATORS, CATEGORY B**

The CCSDS,

considering

- (a) that the balanced modulator is widely used in phase-modulated residual carrier systems as the product modulator for modulating telemetry data on a subcarrier;
- (b) that imperfect subcarrier modulation, caused by phase and amplitude imbalances, results in subcarrier harmonics which, when modulated on the RF carrier, produce an interfering component at the carrier frequency;
- (c) that the interfering component at the RF phase modulator's output may be out of phase with respect to the RF residual carrier, making it undesirable;
- (d) that the magnitude of this interfering component is dependent upon the phase and amplitude imbalances present in the subcarrier modulator;
- (e) that, for a phase imbalance not exceeding 2 degrees and an amplitude imbalance not exceeding 0.2 dB, the RF carrier tracking loop is not significantly affected by the interfering component generated by these phase and amplitude imbalances;
- (f) that, in addition to the interfering component, the phase and amplitude imbalances can contribute to the generation of spurious spectral lines at the spacecraft transmitter's output;
- (g) that these spurious spectral lines can degrade the telemetry bit signal-to-noise ratio (SNR);
- (h) that the telemetry bit SNR degradation, due to phase and amplitude imbalances, can be considered as part of the detection loss and this loss is usually less than 0.1 dB;
- (i) that, for a phase imbalance not exceeding 2 degrees and an amplitude imbalance not exceeding 0.2 dB, the telemetry bit SNR degradation is negligible at bit-error-rates (BERs) less than 10^{-6} ;
- (j) that a subcarrier modulator having a phase imbalance of less than 2 degrees and an amplitude imbalance less than 0.2 dB can be implemented without excessive hardware complexity;

recommends

- (1) that the maximum phase imbalance of the subcarrier modulator shall not exceed 2 degrees;
- (2) that the maximum amplitude imbalance of the subcarrier modulator shall not exceed 0.2 dB.

Earth Stations and Spacecraft

2.4.14A ALLOWABLE VALUES FOR TELEMETRY SUBCARRIER FREQUENCY-TO-SYMBOL RATE RATIOS FOR PCM/PSK/PM MODULATION IN THE 2 AND 8 GHz BANDS, CATEGORY A

The CCSDS,

considering

- (a) that, for Category A missions, a PCM/PSK/PM modulation scheme with a sinewave subcarrier is typically used for transmission of low data rates;
- (b) that integer subcarrier frequency-to-symbol rate ratios (n) result in a data spectral density minimum around the carrier frequency;
- (c) that the subcarrier frequency-to-symbol rate ratio (n) should be minimized to avoid unnecessary occupation of the frequency spectrum;
- (d) that the lowest practicable value of n can be determined by the amount of acceptable interference from the data spectrum (I) into the carrier tracking loop bandwidth (B_L);
- (e) that, for Category A missions, a 0.3 dB degradation in the symbol detection process shall not be exceeded, which requires a 15 dB Carrier-to-Noise ratio (C/N) in the carrier tracking loop, when using CCSDS concatenated coding schemes;
- (f) that any additional degradation, due to data interference in the carrier tracking loop, shall be insignificant for which a C/I ratio greater than 20 dB is considered adequate;
- (g) that, for small ratios of symbol rate-to-carrier tracking loop bandwidth, the modulation index has to be adjusted accordingly in order to achieve the required loop SNR resulting in a nearly constant C/I versus B_L/R_S ;
- (h) that, in the presence of only one telemetry signal, a small value of n ($n = 4$) is generally sufficient to obtain the required performance under typical operating conditions for subcarrier frequencies above 60 kHz;
- (i) that for higher symbol rates, the presence of telecommand feed-through and/or ranging signals may require the selection of a slightly higher value of n ;
- (j) that CCSDS Recommendation 2.4.3 provides guidance regarding the use of subcarriers in low bit rate residual carrier telemetry systems;

recommends

- (1) that the subcarrier frequency-to-symbol rate ratio, n , be an integer value;
- (2) that a subcarrier frequency-to-symbol rate ratio of 4 be selected for subcarrier frequencies above 60 kHz unless *recommends* (3) applies;
- (3) that, in the case of spectral overlaps with other signal components, the minimum integer value of n be selected to permit no more than a 0.3 dB degradation in the symbol detection process.

Earth Stations and Spacecraft

2.4.14B ALLOWABLE VALUES FOR TELEMETRY SUBCARRIER FREQUENCY-TO-SYMBOL RATE RATIOS FOR PCM/PSK/PM MODULATION IN THE 2 AND 8 GHz BANDS, CATEGORY B

The CCSDS,
considering

- (a) that, for Category B missions, a PCM/PSK/PM modulation scheme with a squarewave subcarrier is typically used for transmission of low data rates;
- (b) that integer subcarrier frequency-to-symbol rate ratios (n) result in a data spectral density minimum around the carrier frequency;
- (c) that the subcarrier frequency-to-symbol rate ratio (n) should be minimized to avoid unnecessary occupation of the frequency spectrum;
- (d) that the lowest practicable value of n can be determined by the amount of acceptable interference from the data spectrum (I) into the carrier tracking loop bandwidth (B_L);
- (e) that, for Category B missions, a 0.1 dB degradation in the symbol detection process shall not be exceeded, which requires an 18 dB Carrier-to-Noise ratio (C/N) in the carrier tracking loop, when using CCSDS concatenated coding schemes;
- (f) that any additional degradation, due to data interference in the carrier tracking loop, shall be insignificant for which a C/I ratio greater than 25 dB is considered adequate;
- (g) that, for small ratios of symbol rate-to-carrier tracking loop bandwidth, the modulation index has to be adjusted accordingly in order to achieve the required loop SNR resulting in a nearly constant C/I versus B_L/R_S ;
- (h) that, in the presence of only one telemetry signal, a small value of n ($n = 5$) is generally sufficient to obtain the required performance under typical operating conditions for subcarrier frequencies above 60 kHz;
- (i) that for higher symbol rates, the presence of telecommand feed-through and/or ranging signals may require the selection of a slightly higher value of n ;
- (j) that CCSDS Recommendation 2.4.3 provides guidance regarding the use of subcarriers in low bit rate residual carrier telemetry systems;

recommends

- (1) that the subcarrier frequency-to-symbol rate ratio, n , be an integer value;
- (2) that a subcarrier frequency-to-symbol rate ratio of 5 be selected for subcarrier frequencies above 60 kHz unless *recommends (3)* applies and that subcarrier frequencies do not exceed 300 kHz;¹
- (3) that, in the case of spectral overlaps with other signal components, the minimum integer value of n be selected to permit no more than a 0.1 dB degradation in the symbol detection process.

¹ See SFCG recommendation 23-1 or latest version.

Earth Stations and Spacecraft

**2.4.15A MINIMUM SYMBOL RATE FOR PCM/PM/Bi- ϕ MODULATION ON A
RESIDUAL RF CARRIER, CATEGORY A**

The CCSDS,

considering

- (a) that data modulated on a residual carrier have spectral components which fall into the carrier tracking loop's bandwidth reducing the Carrier-to-Noise ratio (C/N);
- (b) that the level of interference is a function of the carrier tracking loop's bandwidth (B_L), the symbol rate (R_S), and the modulation index (m);
- (c) that a 0.3 dB degradation in the symbol detection process should not be exceeded requiring a Carrier-to-Noise (C/N) ratio in the carrier tracking loop of 10 dB (uncoded case) or 15 dB (CCSDS concatenated coded case);
- (d) that any additional degradation resulting from data interference in the carrier tracking loop must be insignificant requiring a Carrier-to-Interference (C/I) ratio greater than 15 dB (uncoded case) and 20 dB (CCSDS concatenated coded case);

recommends

- (1) that, when no coding is employed, figure 2.4.15A-1 should be used for determining symbol rates (R_S), relative to loop bandwidth (B_L) where PCM/PM/Bi- ϕ modulation is not permitted;
- (2) that, when CCSDS Concatenated coding is employed, figure 2.4.15A-2 should be used for determining symbol rates (R_S), relative to loop bandwidth (B_L), where PCM/PM/Bi- ϕ modulation is not permitted.

Earth Stations and Spacecraft

2.4.15A MINIMUM SYMBOL RATE FOR PCM/PM/Bi- ϕ MODULATION ON A RESIDUAL RF CARRIER, CATEGORY A (Continued)

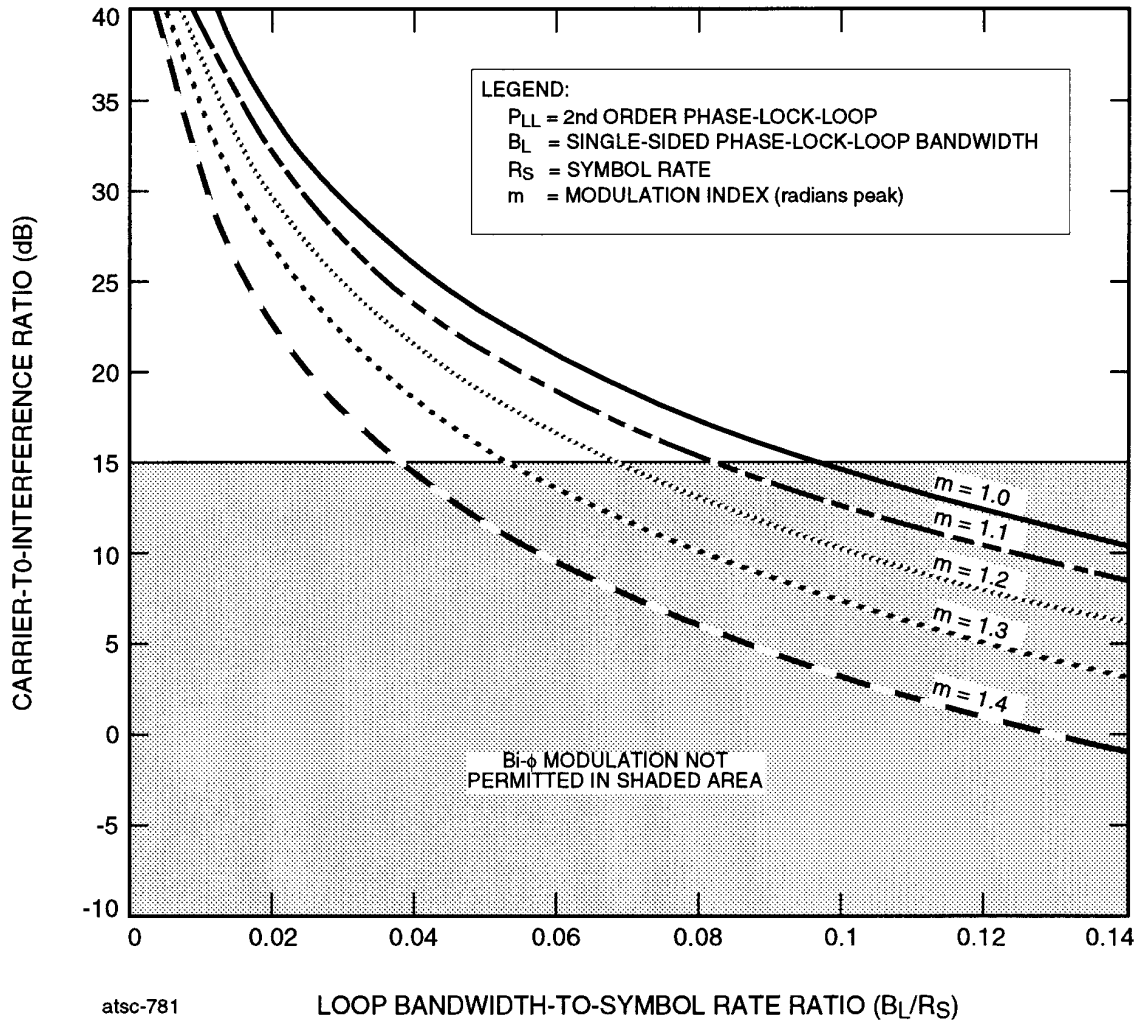

Figure 2.4.15A-1: Operating Region for Use of PCM/PM/Bi- ϕ Modulation When No Coding Is Employed

Earth Stations and Spacecraft

2.4.15A MINIMUM SYMBOL RATE FOR PCM/PM/Bi- ϕ MODULATION ON A RESIDUAL RF CARRIER, CATEGORY A (Continued)

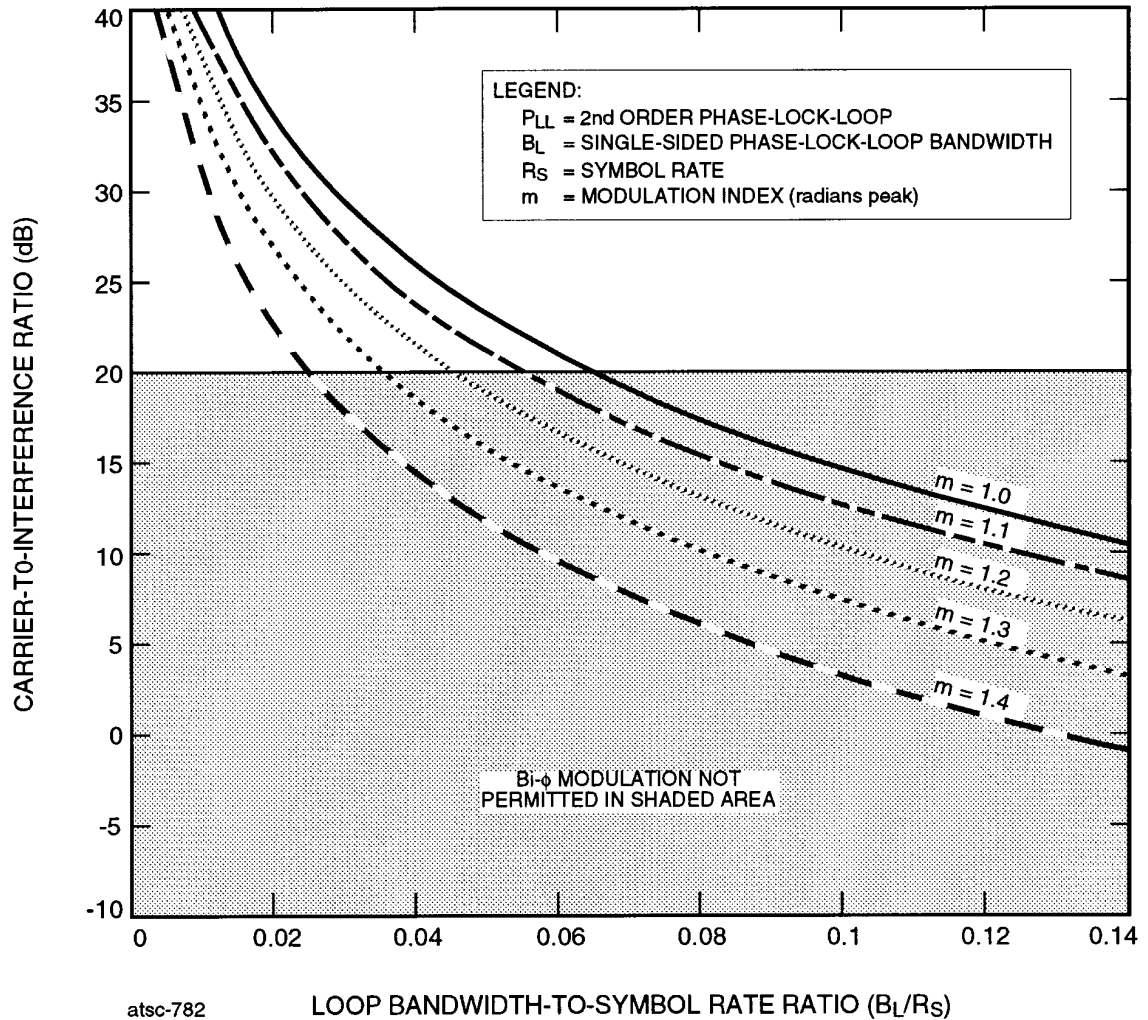

Figure 2.4.15A-2: Operating Region for Use of PCM/PM/Bi- ϕ Modulation When CCSDS Concatenated Coding Is Employed

Earth Stations and Spacecraft

**2.4.15B MINIMUM SYMBOL RATE FOR PCM/PM/Bi- ϕ MODULATION ON A
RESIDUAL RF CARRIER, CATEGORY B**

The CCSDS,

considering

- (a) that data modulated on a residual carrier have spectral components which fall into the carrier tracking loop's bandwidth reducing the Carrier-to-Noise ratio (C/N);
- (b) that the level of interference is a function of the carrier tracking loop's bandwidth (B_L), the symbol rate (R_S), and the modulation index (m);
- (c) that a 0.1 dB degradation in the symbol detection process should not be exceeded requiring a Carrier-to-Noise (C/N) ratio in the carrier tracking loop of 12 dB (uncoded case) or 18 dB (CCSDS concatenated coded case);
- (d) that any additional degradation resulting from data interference in the carrier tracking loop must be insignificant requiring a Carrier-to-Interference (C/I) ratio greater than 17 dB (uncoded case) and 25 dB (CCSDS concatenated coded case);

recommends

- (1) that, when no coding is employed, figure 2.4.15B-1 should be used for determining symbol rates (R_S), relative to loop bandwidth (B_L) where PCM/PM/Bi- ϕ modulation is not permitted;
- (2) that, when CCSDS Concatenated coding is employed, figure 2.4.15B-2 should be used for determining symbol rates (R_S), relative to loop bandwidth (B_L), where PCM/PM/Bi- ϕ modulation is not permitted.

Earth Stations and Spacecraft

2.4.15B MINIMUM SYMBOL RATE FOR PCM/PM/Bi- ϕ MODULATION ON A RESIDUAL RF CARRIER, CATEGORY B (Continued)

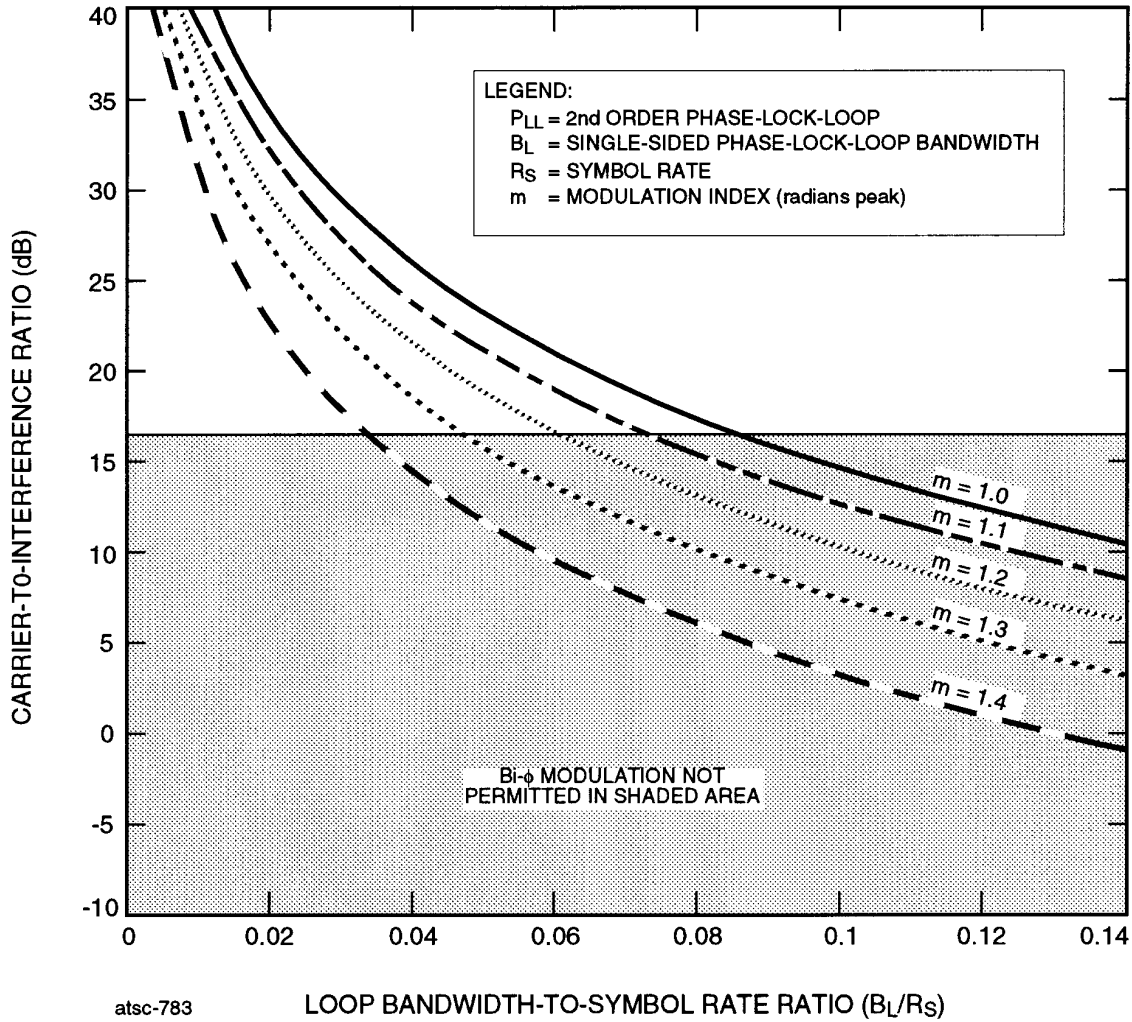

Figure 2.4.15B-1: Operating Region for Use of PCM/PM/Bi- ϕ Modulation When No Coding Is Employed

Earth Stations and Spacecraft

2.4.15B MINIMUM SYMBOL RATE FOR PCM/PM/Bi- ϕ MODULATION ON A RESIDUAL RF CARRIER, CATEGORY B (Continued)

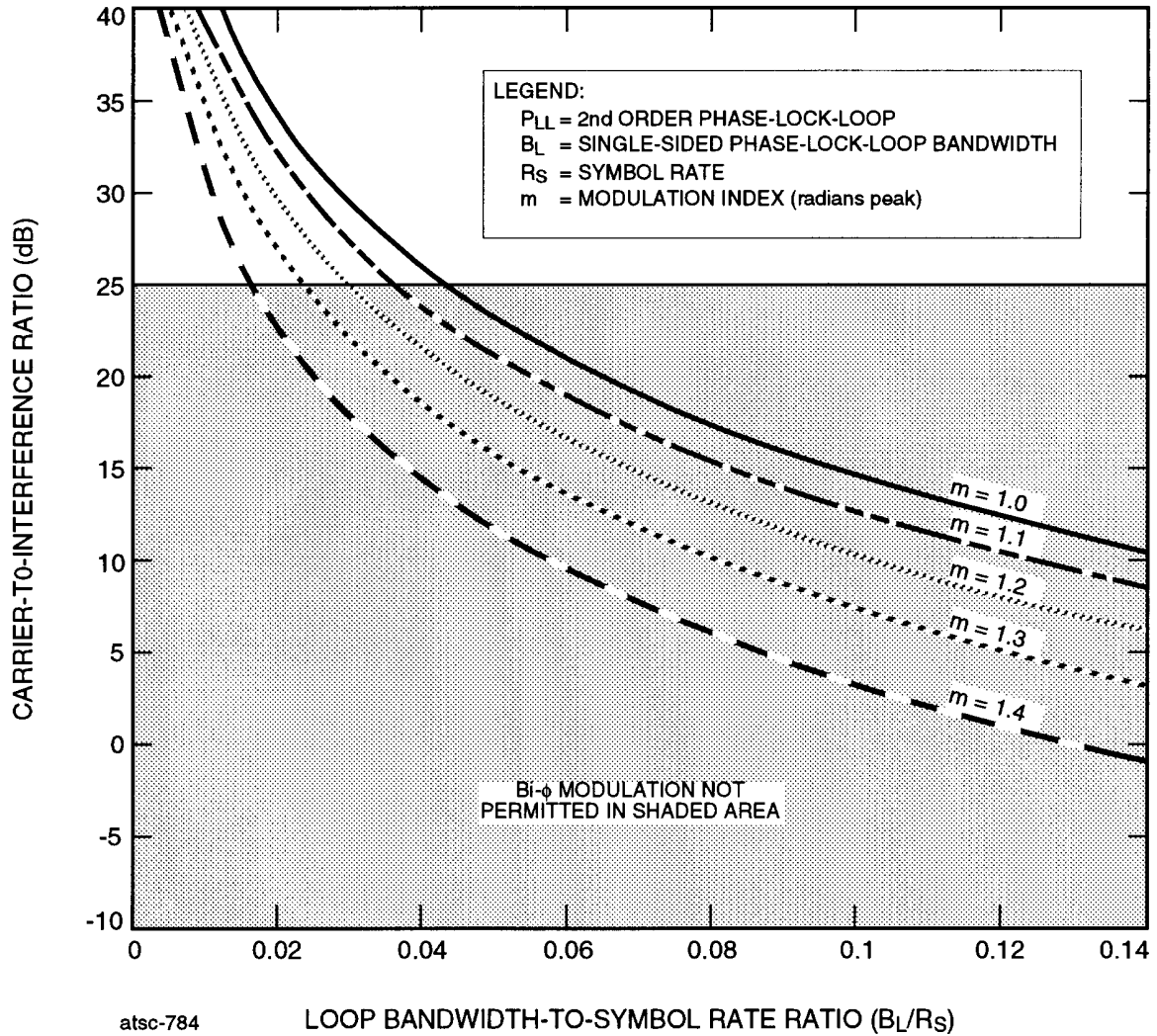

Figure 2.4.15B-2: Operating Region for Use of PCM/PM/Bi- ϕ Modulation When CCSDS CONCATENATED Coding Is Employed

Earth Stations and Spacecraft

2.4.16 MAXIMUM PERMISSIBLE SPURIOUS EMISSIONS

The CCSDS,

considering

- (a) that spurious emissions (ITU-RR-145) in the form of spectral lines can cause harmful interference to receiving stations operating in the allocated or adjacent frequency bands;
- (b) that such spurious emissions are caused by technological imperfections in the transmitting station, such as asymmetry of the baseband modulating waveform and crosstalk of the operating frequencies on the electronic power conditioners;
- (c) that current technology permits reduction of these spectral components to -60 dBc or lower;
- (d) that protection criteria specified for neighboring *radiocommunication services* may require additional reduction of spectral components;
- (e) that filtering can be applied if further reduction in the level of spectral components is required;

recommends

that the total power contained in any single spurious emission shall not exceed -60 dBc.¹

NOTE:

- 1. dBc is measured with respect to the unmodulated carrier level's total power.

Earth Stations and Spacecraft

**2.4.17A MODULATION METHODS FOR HIGH SYMBOL RATE TRANSMISSIONS,
SPACE RESEARCH, SPACE-TO-EARTH, CATEGORY A**

**The CCSDS,
considering**

- (a) that efficient use of RF spectrum resources is imperative with the increasing congestion of the frequency bands;
- (b) that the SFCG has approved a Recommendation,¹ specifying a spectrum mask for *Space Research* Category A Space-to-Earth links operating in certain bands;²
- (c) that suppressed carrier modulation techniques, such as GMSK⁴ and baseband filtered OQPSK⁵ modulations, can meet the SFCG Recommended¹ spectrum mask for symbol rates in excess of 2 Ms/s;
- (d) that since GMSK modulation is inherently differential in nature, the use of GMSK with precoding is necessary to optimize bit error rate performance;
- (e) that GMSK⁴ and baseband filtered OQPSK⁵ modulation types can be demodulated using a conventional OQPSK receiver, but with differing end-to-end losses;
- (f) that GMSK⁴ and baseband filtered OQPSK⁵ modulations have only a small performance degradation as compared with ideal unfiltered suppressed carrier systems;
- (g) that some space agencies currently have no plans to modify their existing OQPSK ground station receivers to optimize reception of GMSK⁴ and baseband filtered OQPSK⁵ signals, so that these two modulation techniques will incur greater losses than unfiltered OQPSK;⁵
- (h) that GMSK and baseband filtered OQPSK modulations have immunity to interference (wideband and narrow band) comparable to unfiltered BPSK when demodulated with an OQPSK receiver matched to an unfiltered OQPSK waveform; the interference immunity of these modulations when demodulated with matched filter receivers is equivalent to or better than BPSK;

recommends⁶

that, to comply with the SFCG Recommendation¹ and to ensure an ability to obtain cross-support in certain *Space Research* service bands² GMSK⁴ or baseband filtered OQPSK⁵ be used for space-to-Earth transmissions when the telemetry data symbol rates exceed 2 Ms/s.

NOTES:

¹ See SFCG Recommendation 21-2R2 or latest version.

² Category A bands are: 2200-2290 MHz and 8450-8500 MHz.

⁴ Gaussian Minimum Shift Keying ($BT_S = 0.25$), with pre-coding as in figure 2.4.17A-1 (see CCSDS 413.0-G-1). B refers to the one-sided 3-dB bandwidth of the filter.

⁵ Filtered (Square Root Raised Cosine $\alpha = 0.5$) Offset QPSK; Butterworth 6 poles, $BT_S = 0.5$; agencies may also utilize filtered OQPSK modulation with other types of bandpass filters provided that the equivalent baseband BT_S is not greater than 0.5 and they ensure compliance with SFCG Recommendation 21-2R2 (or latest version) and interoperability with the cross-supporting networks. B refers to the one-sided 3-dB bandwidth of the filter.

⁶ Space agencies requiring cross-support should consider the performance degradation of the filtered OQPSK and GMSK modulation techniques when received with unmatched demodulators at existing ground stations (see performance data in CCSDS 413.0-G-1); the ordering of modulation types does not imply a preference.

Earth Stations and Spacecraft

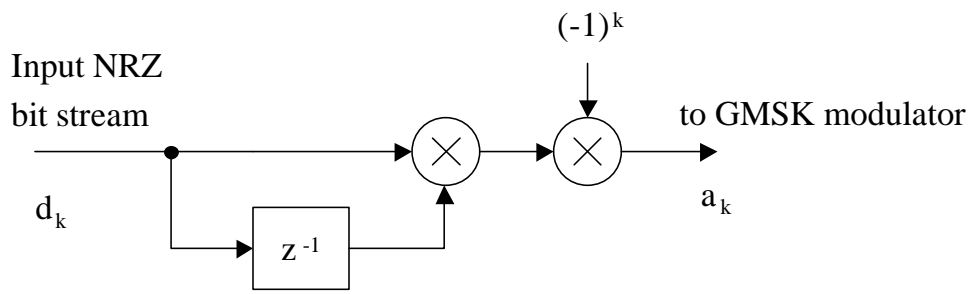

Figure 2.4.17A-1: GMSK Precoder

Earth Stations and Spacecraft

**2.4.17B MODULATION METHODS AT HIGH SYMBOL RATE TRANSMISSIONS,
SPACE RESEARCH, SPACE-TO-EARTH, CATEGORY B**

The CCSDS,

considering

- (a) that in accordance with ITU RR 3.9, efficient use of the RF spectrum resources is required;
- (b) that the SFCG has approved an Efficient Spectrum Utilization Recommendation¹ which specifies maximum allowable bandwidth (B25)¹ guidelines based on the symbol rate for emissions in the Space Research, Category B, 8 GHz band;
- (c) that the maximum bandwidth (B25)¹ in the Space Research, Category B, 8 GHz band under the SFCG Recommendation¹ is limited to 12 MHz for non-Mars missions on a non-interfering basis to other missions and 8 MHz in all other cases;
- (d) that the Space Research, Category B, frequency allocation at 2 GHz is 10 MHz, requiring high symbol rate users sharing the band to be spectrally efficient;
- (e) that 2 Ms/s is used as a boundary for the definition of high symbol rate for Space Research, Category A, Space-to-Earth transmissions in both the 2 and 8 GHz bands;²
- (f) that GMSK³ is a spectrally efficient modulation with negligible end-to-end losses using an optimized receiver;
- (g) that since GMSK modulation is inherently differential in nature, the use of GMSK with precoding is necessary to optimize bit error rate performance;
- (h) that short periodic data patterns can result in zero power at the carrier frequency;

recommends

- (1) that GMSK³ be used for high data rate transmissions whenever practicable and in any case for rates in excess of 2 Ms/s in communications systems operating in either the 2 or 8 GHz bands, provided that in no case the transmission bandwidth (B25)¹ exceed that recommended by the SFCG;¹
- (2) that Category B missions requiring transmission bandwidths (B25)¹ higher than that recommended⁴ by the SFCG in 8 GHz band, use the 31.8-32.3 GHz band instead;
- (3) that CCSDS agencies use a data randomizer as specified in the CCSDS telemetry synchronization and channel coding blue book 131.0-B-1 (or latest edition).

NOTES:

¹ See SFCG Recommendation 23-1 or latest version.

² See CCSDS Recommendation 401 (2.4.17A) B-1.

³ Gaussian Minimum Shift Keying ($BT_s = 0.5$), with precoding as in figure 2.4.17B-1 (see CCSDS 413.0-G-1). B refers to the one-sided 3-dB bandwidth of the filter.

⁴ Under the 12 MHz bandwidth limitation for non-Mars missions on a non-interfering basis, the maximum symbol rate using GMSK $BT_s=0.5$ is 9.3 Ms/s. For Mars missions and non-Mars missions which interfere with Mars missions, the maximum symbol rate using GMSK $BT_s=0.5$ is 6.2 Ms/s.

Earth Stations and Spacecraft

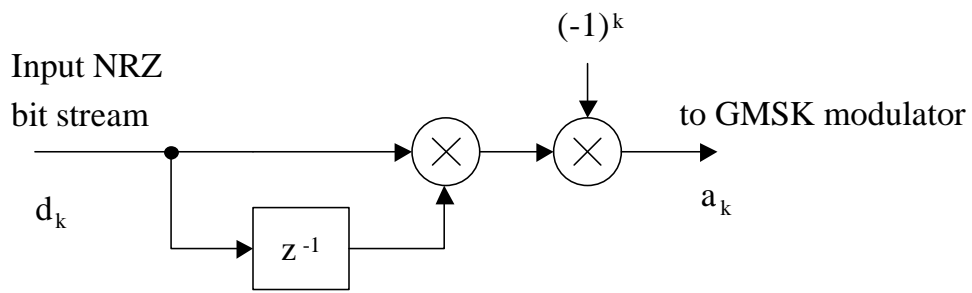

Figure 2.4.17B-1: GSMK Precoder

Earth Stations and Spacecraft

**2.4.18 MODULATION METHODS AT HIGH SYMBOL RATE TRANSMISSIONS,
EARTH EXPLORATION SATELLITES (EES) 8 GHZ BAND, SPACE-TO-
EARTH**

**The CCSDS,
considering**

- (a) that efficient use of RF spectrum resources is becoming increasingly important with the increasing congestion of the frequency bands;
- (b) that the 8025-8400 MHz band is heavily used and interference conflicts may become increasingly frequent in this band;
- (c) that the SFCG has approved a Recommendation¹ which specifies a spectrum mask for emissions with symbol rates below and above 2 Ms/s;
- (d) that the SFCG has approved a Recommendation² on the use of the 8025-8400 MHz band recommending that bandwidth- and power-efficient modulation and coding techniques be used;
- (e) that the CCSDS 131.0-B-1, *TM Synchronization and Channel Coding*, foresees a number of coding schemes, some of which may be incompatible with the bandwidth-efficient use of the 8025-8400 MHz band;
- (f) that contiguous to 8400 MHz, a particularly sensitive allocation to Space Research, deep space, requires adequate protection from unwanted emissions generated by EES;³
- (g) that only filtered suppressed carrier systems can meet the bandwidth efficiency of SFCG spectrum mask Recommendation¹ for symbol rates in excess of 2 Ms/s and limit unwanted emissions into the neighboring bands;
- (h) that Square Root Raised Cosine filtered 4-Dimensional 8 PSK Trellis Coded Modulation (SRRC-4D 8PSK TCM),⁴ GMSK,⁵ and some filtered OQPSK⁶ modulations spectra can meet the SFCG emission mask for symbol rates in excess of 2 Ms/s with acceptable end-to-end losses;
- (i) that SRRC 4D 8PSK TCM offers better link performance than uncoded GMSK and filtered Offset QPSK for the same or better bandwidth efficiency;
- (j) that current technology allows implementing and processing of SRRC-4D 8PSK TCM modulation at the rates required in the band;
- (k) that filtered OQPSK receivers are readily available in most space agencies' ground networks;

¹ See SFCG Recommendation 21-2R2 or latest version.

² See SFCG Recommendation 14-3R7 or latest version.

³ See SFCG Recommendation 14-1 or latest version.

⁴ Square Root Raised Cosine ($\alpha = 0.35$ and $\alpha = 0.5$) 4D 8PSK Trellis Coded Modulation. See CCSDS 413.0-G-1.

⁵ Gaussian Minimum Shift Keying ($BT_s = 0.25$), with precoding. See CCSDS 413.0-G-1.

⁶ Square Root Raised Cosine ($\alpha = 0.5$) Filtered Offset QPSK; Butterworth Bandpass Filtered (6 poles, $BT_s = 1.0$) Offset QPSK. See CCSDS 413.0-G-1.

Earth Stations and Spacecraft

**2.4.18 MODULATION METHODS AT HIGH SYMBOL RATE TRANSMISSIONS,
EARTH EXPLORATION SATELLITES (EES) 8 GHZ BAND, SPACE-TO-
EARTH (Continued)**

noting

- (1) that GMSK or filtered OQPSK signals can also be demodulated by OQPSK receivers with some mismatching losses;⁷
- (2) that many missions are currently operating in this band with a signaling efficiency⁸ over 1.75 source bits/channel symbol;

recommends

- (1) that a mission planning to operate in the 8025-8400 MHz band use SRRC-4D 8PSK TCM⁹ or GMSK¹⁰ or filtered OQPSK;¹¹
- (2) that a mission planning to use this band select the most bandwidth-efficient channel coding scheme from CCSDS 131.0-B-1 compatible with the mission constraints.

⁷ See Appendix B.4 of CCSDS 413.0-G-1 for GMSK, SRRC, and Butterworth filtered OQPSK mismatching losses.

⁸ Ratio of source data rate to channel symbol rate.

⁹ Available options are 2.0 b/s/Hz, 2.25 b/s/Hz, 2.5 b/s/Hz and 2.75 b/s/Hz; Square Root Raised Cosine filter with $\alpha = 0.35$ or $\alpha = 0.5$. See CCSDS 413.0-G-1.

¹⁰ Gaussian Minimum Shift Keying ($BT_s = 0.25$), with precoding. See CCSDS 413.0-G-1.

¹¹ Square Root Raised Cosine ($\alpha = 0.5$) Filtered Offset QPSK; Butterworth Bandpass Filtered (6 poles, $BT_s = 1.0$) Offset QPSK. See CCSDS 413.0-G-1. Agencies may also utilize baseband-filtered OQPSK modulation with other types of Bandpass filters provided that BT_s is not greater than 1.0 and they ensure compliance with SFCG Recommendation 21-2R2 (or latest version) and interoperability with the cross-supporting networks.

Earth Stations and Spacecraft

2.4.19 TELEMETRY SYMBOL RATE STABILITY IN SUPPRESSED CARRIER TELEMETRY SYSTEMS

The CCSDS,

considering

- (a) that the use of suppressed carrier modulation schemes for the space-to-Earth RF links as in CCSDS 401.0 recommendations 2.3.2, 2.4.17A, 2.4.17B and 2.4.18 is recommended under the conditions specified in the above CCSDS recommendations;
- (b) that symbol rate offsets and instabilities may result in demodulation performance degradation at the receiving station;

recommends

that spacecraft radio frequency subsystems utilizing suppressed carrier modulation be designed with characteristics equal to or better than:

Maximum Symbol Rate Offset	± 100 ppm;
Minimum Symbol Rate Stability (short term); ¹	$\pm 1 \times 10^{-6}$
Minimum Symbol Rate Stability (long term). ²	$\pm 1 \times 10^{-5}$

¹ Short term time intervals are less than or equal to 100 times the symbol period.

² Stability over 5 minutes.

Earth Stations and Spacecraft

2.4.20B MODULATION METHODS AT HIGH SYMBOL RATE TRANSMISSIONS FOR THE 31.8-32.3 GHz BAND, SPACE RESEARCH, SPACE-TO-EARTH, CATEGORY B

The CCSDS,

considering

- (a) that in accordance with ITU RR S3.9, efficient use of the RF spectrum resources is required;
- (b) that the 32 GHz band is planned to become the backbone for communications with high rate Category B missions;
- (c) that the Space Research, Category B, frequency allocation at 8 GHz is 50 MHz wide, and missions with symbol rates higher than 2 Ms/s are required to utilize spectrally efficient modulation;¹
- (d) that the Space Research, Category B, 32 GHz frequency allocation is 500 MHz wide, and therefore 20 Ms/s is the corresponding value for the 32 GHz band;
- (e) that GMSK ($BT_S = 0.5$)² is a spectrally efficient modulation with negligible end-to-end losses using an optimized receiver, making it an excellent choice for weak signal-level missions;
- (f) that since GMSK modulation is inherently differential in nature, the use of GMSK with precoding is necessary to optimize bit error rate performance;
- (g) that short periodic data patterns can result in zero power at the carrier frequency;

recommends

- (1) that GMSK ($BT_S = 0.5$)² be used for high data rate transmissions whenever practicable at symbol rates below 20 Ms/s and in any case for rates equal to or in excess of 20 Ms/s in communications systems operating in the 32 GHz bands;
- (2) that CCSDS agencies use a data randomizer as specified in the CCSDS Recommended Standard, TM Synchronization and Channel Coding, CCSDS 131.0-B-1 (or latest edition).

NOTES:

¹ See CCSDS Recommendation 401 (2.4.17B) B-2.

² Gaussian Minimum Shift Keying ($BT_S = 0.5$), with precoding as in figure 2.4.20B-1 (see CCSDS 413.0-G-1). B refers to the one-sided 3-dB bandwidth of the filter.

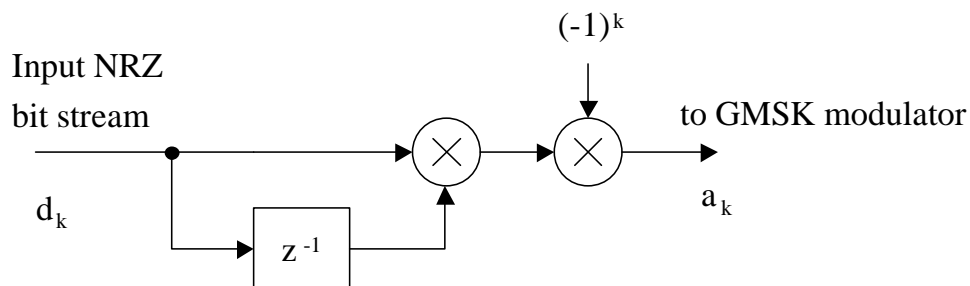

Figure 2.4.20B-1: GMSK Precoder

Earth Stations and Spacecraft

**2.5.1A MINIMUM EARTH STATION GROUP DELAY CALIBRATION ACCURACY,
CATEGORY A**

The CCSDS,

considering

- (a) that Earth station group delay calibrations must include all equipment used for ranging measurements;
- (b) that the path used for Earth station group delay calibration is not always identical with the path used for ranging measurements;
- (c) that Earth station group delay calibrations require frequency translation to close the loop between the Earth station's transmitting and receiving equipment;
- (d) that frequency translation requires the use of a transponder or frequency translator which will not be in the path during ranging measurements;
- (e) that the group delay measurement error, exclusive of frequency translation, can reasonably be kept as low as 2 nanoseconds;
- (f) that the group delay measurement error of the frequency translation equipment can also be kept as low as 2 nanoseconds;
- (g) that, where a frequency translator is employed to close the loop between the Earth station's transmitting and receiving equipment, the ranging tone modulation indices used for up- and/or down-link during calibrations are generally not the same as those used during ranging measurements;
- (h) that the group delay variation of the Earth station receiver resulting from the use of different modulation indices does not exceed 4 nanoseconds;
- (i) that the calibration error due to spurious modulation in the Earth station's equipment does not exceed 2 nanoseconds;

recommends

that the Earth station's group delay be calibrated with an accuracy better than, or equal to, 10 nanoseconds for Category A missions.

Earth Stations and Spacecraft

**2.5.1B MINIMUM EARTH STATION GROUP DELAY CALIBRATION ACCURACY,
CATEGORY B**

The CCSDS,

considering

- (a) that Earth station group delay calibrations must include all equipment used for ranging measurement;
- (b) that Earth station group delay calibrations require frequency translation to close the loop between the Earth station's transmitting and receiving equipment;
- (c) that the group delay measurement error of the uplink and downlink ranging system, exclusive of the frequency translation, can reasonably be kept as low as five nanoseconds;
- (d) that the group delay measurement error of the frequency translation equipment can be kept as low as three nanoseconds;
- (e) that other factors affecting group delay measurement error can reasonably be kept as low as three nanoseconds;
- (f) that these measurement error contributions are largely independent, and the total error formed from the root sum squares of the individual error contributions is less than seven nanoseconds ($1-\sigma$);
- (g) that for navigation purposes, two meter range accuracy ($1-\sigma$) is sufficient for most Category B missions in the 8400-8450 MHz band;
- (h) that a ground station group delay variation of no more than seven nanoseconds is consistent with two meter range accuracy, allowing for additional range error sources including media and spacecraft delay variation;

recommends

that the Earth station's 7145-7190 MHz uplink/8400-8450 MHz downlink group delay be calibrated with an accuracy better than, or equal to, seven nanoseconds ($1-\sigma$) for Category B missions.

Earth Stations and Spacecraft

**2.5.2A MINIMUM EARTH STATION RANGING GROUP DELAY STABILITY,
CATEGORY A**

The CCSDS,

considering

- (a) that most space agencies use ranging measurements for spacecraft orbit or trajectory determination;
- (b) that a ranging accuracy of 10 meters is generally adequate to meet the orbit or trajectory determination accuracy required by Category A missions;
- (c) that the accuracy of the ranging measurement is dependent upon the following factors:
 - the accuracy with which the station has been located on a geodetic grid;
 - the accuracy with which the medium can be modeled;
 - the accuracy of the frequency and timing system;
 - the accuracy with which the ranging channel's group delay has been calibrated;
 - the ranging data noise;
 - the group delay variations between calibrations;
- (d) that the ground system's contribution to the total 10 meter ranging error can be limited to 30 percent of the total;
- (e) that the elapsed time between the ranging calibration and the actual measurement can be limited to 12 hours or less;

recommends

that the total group delay variation in the ground station ranging equipment, over any 12-hour period, shall not exceed 20 nanoseconds.

Earth Stations and Spacecraft

**2.5.2B MINIMUM EARTH STATION RANGING GROUP DELAY STABILITY,
CATEGORY B**

The CCSDS,

considering

- (a) that most space agencies use ranging measurements for spacecraft orbit or trajectory determination;
- (b) that precision range measurements are frequently required to meet the scientific objectives of Category B missions;
- (c) that the ranging data can yield scientific information about the medium and other physical phenomena;
- (d) that the value of the information obtained from the ranging measurement for scientific purposes is directly related to its accuracy;
- (e) that to satisfy the needs of all users, the ranging system should be capable of measurement accuracies of three meters or better;
- (f) that the accuracy of the ranging measurement is dependent upon the following factors:
 - the accuracy with which the station has been located on a geodetic grid;
 - the accuracy with which the medium can be modeled;
 - the accuracy of the frequency and timing system;
 - the accuracy with which the ranging channel's group delay has been calibrated;
 - the ranging data noise;
 - the group delay variations between calibrations;
- (g) that, in order to meet the measurement accuracies set forth in (e) above, it is important to control the magnitude of the error sources listed in (f) above;
- (h) that group delay variations in the ground station ranging equipment, which occur between calibrations of that delay, should not exceed ten percent of the total error budget;
- (i) that the elapsed time between the ranging calibration and the actual measurement can be limited to 12 hours or less;
- (j) that short term variations in group delay affect range rate measurements which are sometimes required for range measurement;

recommends

- (1) that the total group delay variation in the ground station ranging equipment, over any 12 hour period, shall not exceed 2 nanoseconds;
- (2) that the derivative of the group delay (in a mean square sense) with time is within ± 0.1 mm/s.

Earth Stations and Spacecraft

**2.5.3A MINIMUM SPACECRAFT RANGING CHANNEL GROUP DELAY
STABILITY, CATEGORY A**

The CCSDS,

considering

- (a) that most space agencies use ranging measurements for spacecraft orbit or trajectory determination;
- (b) that a distance measurement accuracy of 10 meters is generally adequate to meet the orbit or trajectory determination accuracies required by Category A missions;
- (c) that the highest frequency ranging signal determines the precision of the range measurement;
- (d) that the principal delay encountered by the highest frequency ranging signal results from the narrow band filter in the transponder's ranging channel;
- (e) that, in the absence of thermal noise, the spacecraft transponder's contribution to the total 10-meter ranging error should not exceed 15 percent of the total;
- (f) that transponder ranging channel phase linearity is desirable since it facilitates removing the range ambiguities;
- (g) that a linear phase response of transponder's ranging channel can be achieved with a four-pole Bessel bandpass filter having a one-sided bandwidth of 200 kHz and a group delay of 10 microseconds;
- (h) that a group delay stability of a few percent is easily achievable for such a filter;

recommends

- (1) that the delay variation of the highest frequency ranging signal, which occurs in the spacecraft's transponder, shall not exceed ± 50 nanoseconds;
- (2) that pre-launch calibrations, together with telemetered data (voltage, temperature, static phase error, etc.) be sufficient to permit calculation of the transponder's ranging channel group delay with an accuracy of ± 5 nanoseconds at any time;
- (3) that recommendations (1) and (2) are applicable over the full range of Doppler frequencies, input signal level, temperatures, and voltages encountered during the mission's lifetime.

NOTE:

- 1. For ranging transponder bandwidth, refer to Recommendation 401 (2.5.4A).

Earth Stations and Spacecraft

2.5.3B MINIMUM SPACECRAFT RANGING CHANNEL GROUP DELAY STABILITY, CATEGORY B

The CCSDS,

considering

- (a) that most space agencies use ranging measurements for spacecraft orbit or trajectory determination;
- (b) that a distance measurement accuracy of 3 meters is generally adequate to meet the orbit or trajectory determination accuracies required by Category B missions;
- (c) that the highest frequency ranging signal determines the precision of the range measurement;
- (d) that the principal delay encountered by the highest frequency ranging signal results from the narrow band filter in the transponder's ranging channel;
- (e) that, in the absence of thermal noise, the spacecraft transponder's contribution to the total 3-meter ranging error should not exceed 25 percent of the total;
- (f) that transponder ranging channel phase linearity is desirable since it facilitates removing the range ambiguities;
- (g) that a linear phase response of transponder's ranging channel can be achieved with a four-pole Bessel bandpass filter having a one-sided bandwidth of 3.5 MHz and a group delay of 600 nanoseconds;
- (h) that a filter group delay stability of a few percent is easily achievable;
- (i) that transponders with two or more space-to-Earth links having frequency diversity provide a means for determining range measurement errors induced by charged particles if the group delay difference(s) between the transponder's ranging channels is known with great accuracy;

recommends

- (1) that the delay variation of the highest frequency ranging signal, which occurs in the spacecraft's transponder, shall not exceed ± 30 nanoseconds;
- (2) that pre-launch calibrations, together with telemetered data (voltage, temperature, static phase error, etc.) be sufficient to permit calculation of the transponder's ranging channel group delay with an accuracy of ± 2.5 nanoseconds at any time;
- (3) that the variation in differential delay between any two channels in a single transponder be less than ± 2 nanoseconds;
- (4) that the above recommendations are applicable over the full range of Doppler frequencies, input signal level, temperatures, and voltages encountered during the mission's lifetime.

NOTE:

- 1. For ranging transponder bandwidth, refer to Recommendation 401 (2.5.4B).

Earth Stations and Spacecraft

2.5.4A RANGING TRANSPONDER BANDWIDTH FOR RESIDUAL CARRIER SYSTEMS, CATEGORY A

The CCSDS,

considering

- (a) that, for most missions, the ranging signals occupy a larger bandwidth than telecommand or housekeeping telemetry signals;
- (b) that it is important to limit the occupied bandwidth in the Category A mission frequency bands;
- (c) that sine-wave ranging modulation is used for limiting the occupied bandwidth;
- (d) that range measurement precision increases with the frequency of the highest frequency (major) ranging tone;
- (e) that most space agencies presently utilize a 100 kHz major tone as a compromise between range measurement precision and bandwidth occupancy;
- (f) that most space agencies currently employ tones at or above 4 kHz;
- (g) that the spacecraft transponder's ranging filter must reject d.c. and very low frequencies so that the residual carrier energy is not re-modulated on the return link;
- (h) that it is important to minimize Earth-to-space link noise which is re-modulated on the space-to-Earth link;
- (i) that high phase linearity of the spacecraft transponder's ranging channel filter over its bandwidth facilitates removing range ambiguities when multiple range tones are used;
- (j) that the ranging transponder's bandwidth can be adequately controlled using a 4-pole Bessel linear-phase bandpass filter which properly defines the attenuation roll-off characteristics;

recommends

- (1) that spacecraft transponders incorporate a bandpass filter in their ranging channel;
- (2) that the transponder ranging channel's baseband frequency response be uniform within ± 0.5 dB within the frequency range 3 kHz to 110 kHz;
- (3) that the transponder's ranging channel be designed to not deviate more than ± 6 degrees from a linear phase-frequency relationship within the bandwidth stated in *recommends (2)*.

Earth Stations and Spacecraft

2.5.4B RANGING TRANSPONDER BANDWIDTH FOR RESIDUAL CARRIER SYSTEMS, CATEGORY B

The CCSDS,

considering

- (a) that range measurement precision increases with the frequency of the highest frequency (major) range code component;
- (b) that some space tracking systems for Category B missions employ square-wave ranging modulation having range code component frequencies from 1 Hz to 1 MHz;
- (c) that other spacecraft tracking systems for Category B missions employ sine wave tones, which can be selected in frequency from 100 kHz to 1 MHz, which may be phase modulated by a square wave code;
- (d) that these systems are designed to bi-phase modulate the high frequency code component with the low frequency code components to reduce interference with the telecommand and telemetry signals;
- (e) that the ranging transponder's bandwidth required to accommodate the ranging codes described in (b) permit flexibility in the selection of the types of ranging codes and modulation techniques;
- (f) that the ranging transponder's bandwidth can be adequately controlled using a 4-pole Bessel linear-phase bandpass filter which properly defines the attenuation roll-off characteristics;
- (g) that some margin should be included in the transponder filter's bandwidth to ensure proper operation with the commonly used 1 MHz tone or code;

recommends

- (1) that spacecraft transponders incorporate a bandpass filter in their ranging channel;
- (2) that the transponder ranging channel's baseband frequency response be uniform within ± 0.5 dB within the frequency range 3 kHz to 1.1 MHz;
- (3) that the one-half power (-3 dB) bandpass frequencies of the transponder's ranging channel be greater than 3 MHz and less than 1 kHz;
- (4) that the transponder's ranging channel be designed to not deviate more than ± 6 degrees from a linear phase-frequency relationship within the bandwidth stated in *recommends (3)*;
- (5) that the one-sided equivalent noise bandwidth be limited to 3.5 MHz.

Earth Stations and Spacecraft

**2.5.5A PN CODE PHASE SHIFT STABILITY REQUIRED IN SPACECRAFT
SPREAD SPECTRUM REGENERATIVE RANGING TRANSPONDERS,
CATEGORY A**

The CCSDS,

considering

- (a) that most agencies use ranging measurements for spacecraft orbit or trajectory determination;
- (b) that Pseudo-Noise (PN) code sequences are used by some spacecraft transponders to make ranging measurements;
- (c) that, in the ranging mode, these transponders must synchronize an on-board PN code generator to the received PN code;
- (d) that, usually, the Earth-to-space link's signal-to-noise ratio in the ranging code's tracking loop is sufficiently large so that the phase error in the spacecraft's code tracking loop is an insignificant part of the ranging measurement error;
- (e) that a 1-sigma distance measurement accuracy of 10 meters is generally sufficient to meet the orbit or trajectory determination requirements of Category A missions;
- (f) that the spacecraft transponder's contribution to the total 10 meter distance measurement error should not exceed 30 percent of the total;
- (g) that the variation of transponder's temperature is the principal cause of instability in the time delay and is normally measured and recorded prior to launch;

recommends

that the time delay of PN codes through a spacecraft's transponder should not vary from its calibrated, pre-launch value by more than 20 nanoseconds.

Earth Stations and Spacecraft

2.5.6B DIFFERENTIAL ONE-WAY RANGING FOR SPACE-TO-EARTH LINKS IN ANGULAR SPACECRAFT POSITION DETERMINATION, CATEGORY B

The CCSDS,

considering

- (a) that Very Long Baseline Interferometry (VLBI) measurement allow determination of geometric delay for space radio sources by the simultaneous reception and processing of radio signals at two stations;
- (b) that using the VLBI geometric delay measurements from two stations, the angular position of a spacecraft can be accurately determined for navigational purposes;
- (c) that the VLBI technique requires differencing phase measurements of sinusoidal tones or harmonics (known as Differential One-way Ranging [DOR] tones), modulated on the spacecraft's downlink RF carrier, which have been acquired at two (or more) stations;
- (d) that VLBI accuracy depends upon a priori knowledge of both the length and orientation of the baseline vector between the stations, the station clock drift, and the media delays;
- (e) that measurement errors can be greatly reduced by observing a quasar or Extra-Galactic Radio source (EGRS), that is angularly near the spacecraft, and then differencing the delay measured from the ERGS observation with the delay measured from observing the spacecraft (Δ DOR);
- (f) that the spacecraft delay measurement's precision depends upon the received power (P_{DOR}) in the two most widely spaced DOR tones, f_{BW} Hz apart, as shown in the error relationship:

$$\epsilon_{\tau} = \left[f_{BW} \sqrt{4 \pi \frac{P_{DOR}}{N_0} T_{obs}} \right]^{-1} \text{ seconds, where:}$$

$$f_{BW} = \text{DOR tone spanned bandwidth}^1 \text{ (Hz)}$$

$$T_{obs} = \text{observation time (seconds);}$$

- (g) that a narrow spanned bandwidth is needed for integer cycle ambiguity resolution because the Δ DOR time delay ambiguity equals the reciprocal of the minimum spanned bandwidth;
- (h) that, contrary to *considering (g)*, a wide spanned bandwidth is needed for high measurement accuracy;
- (i) that doubling the spanned bandwidth of spacecraft DOR tones, while holding the other parameters fixed, will reduce errors resulting from low spacecraft SNR, low quasar SNR, and instrument phase ripple by half;
- (j) that delay ambiguities in observables generated from wider bandwidths are resolved successively by using delay estimates from the narrower spanned bandwidths;

¹ The spanned bandwidth is the widest separation between detectable tones in the downlink spectrum. This is usually given as twice the frequency of a sinusoidal "DOR Tone" modulated onto the carrier.

Earth Stations and Spacecraft

2.5.6B DIFFERENTIAL ONE-WAY RANGING FOR SPACE-TO-EARTH LINKS IN ANGULAR SPACECRAFT POSITION DETERMINATION, CATEGORY B (Cont.)

- (k) that a typical Δ DOR error budget is dominated by errors due to low quasar SNR, quasar position uncertainty, instrument phase ripple, and the troposphere;
- (l) that EGRS delay measurement precision and instrument errors vary as $1/f_{BW}$;
- (m) that direct phase modulation of a sinewave tone on the downlink RF carrier is more spectrum efficient than squarewave modulation and allows appropriate choices of spanned bandwidth and tone power;
- (n) that the received spacecraft DOR tone power must be adequate for tone detection, with the threshold approximately determined by:

$$Threshold = \left[\frac{P_{DOR}}{N_0} \right] = 13 \text{ dB} \cdot \text{Hz if no carrier aiding is used;}$$

- (o) that the DOR tone threshold reduces to:

$$Threshold = \left[\frac{P_{DOR}}{N_0} \right] = 1 \text{ dB} \cdot \text{Hz}$$

provided that the spacecraft RF carrier's SNR is greater than 13 dB and that the extracted carrier phase is used to aid in tracking the DOR tone whose frequency is a coherent submultiple of the spacecraft's RF carrier frequency;

- (p) that the stability of the spacecraft's RF carrier stability, over a 1-second averaging time, must be adequate for signal detection;
- (q) that the *Space Research service* frequency allocation for Category B missions is 10 MHz in the 2 GHz band, 50 MHz in the 8 GHz band, 400 MHz in the 32 GHz band, and 1 GHz in the 37 GHz band;
- (r) that quasar flux is reduced and system noise temperature is higher at 32 and 37 GHz as compared to 8 GHz;

recommends

- (1) that DOR tone be sinewaves;
- (2) that either direct tone detection or carrier-aided tone detection be used;
- (3) that DOR tones be coherent with the downlink RF carrier frequency if carrier-aided detection is used;
- (4) that one DOR tone pair be used in the 2 GHz band, two DOR tone pairs be used in the 8 GHz band, and three DOR tone pairs be used in the 32 and 37 GHz bands;

Earth Stations and Spacecraft

2.5.6B DIFFERENTIAL ONE-WAY RANGING FOR SPACE-TO-EARTH LINKS IN ANGULAR SPACECRAFT POSITION DETERMINATION, CATEGORY B (Cont.)

- (5) that the approximate DOR tone frequencies used in each band be those in Table 2.5.6-1;

TABLE 2.5.6-1: RECOMMENDED DOR TONES

Space-to-Earth Frequency Band	Number of DOR Tones	Approximate DOR Tone Frequencies ($\pm 10\%$)
2 GHz	1	4 MHz
8 GHz	2	4 MHz and 20 MHz
32 & 37 GHz	3	4 MHz, 20 MHz, and 76 MHz

NOTE – Depending on mission requirement (accuracy versus integration time), lower tone frequencies (< 4 MHz) may be used. In this case, if the down-link modulator is to be implemented digitally, square-wave DOR modulation may be applied in order to reduce transponder complexity.

- (6) that, if spacecraft DOR data are to be acquired in the one-way mode, the spacecraft's oscillator stability over a 1-second averaging time shall be:

$$\begin{aligned} \Delta f/f &\leq 4.0 \times 10^{-10} \text{ at 2 GHz,} \\ \Delta f/f &\leq 1.0 \times 10^{-10} \text{ at 8 GHz,} \\ \Delta f/f &\leq 0.3 \times 10^{-10} \text{ at 32 and 37 GHz} \end{aligned}$$

where: $\Delta f/f$ denotes the spacecraft oscillator's frequency variations (square root of Allan's variance).

Earth Stations and Spacecraft

**2.6.1 TRANSPONDER TURNAROUND FREQUENCY RATIOS FOR THE
2025 — 2120 MHz AND 2200 — 2300 MHz BANDS**

The CCSDS,

considering

- (a) that a great number of space missions, which require coherency between the Earth-to-space and space-to-Earth links for development of navigational data, operate in the above frequency bands;
- (b) that for space missions which require coherency, a turnaround frequency ratio must be defined;
- (c) that many CCSDS agencies have used the 221/240 turnaround ratio in their space missions for many years;
- (d) that many CCSDS agencies have developed equipment using this ratio for their spacecraft and Earth stations which represent a large financial investment;
- (e) that the 221/240 turnaround frequency ratio adequately translates the 2025 - 2120 MHz band to the 2200 - 2300 MHz band;

recommends

- (1) that CCSDS agencies continue to use the 221/240 turnaround frequency ratio for Category A and Category B space missions which are operating in the above bands;
- (2) that this turnaround frequency ratio is only necessary for those space missions which require both cross support from other agencies' Earth stations and coherency between the Earth-to-space and space-to-Earth links.

Earth Stations and Spacecraft

**2.6.2 TRANSPONDER TURNAROUND FREQUENCY RATIOS FOR THE
7145 — 7235 MHz AND 8400 — 8500 MHz BANDS**

The CCSDS,

considering

- (a) that a great number of space missions which require coherency between the Earth-to-space and space-to-Earth links for development of navigational data operate in the above frequency bands;
- (b) that for space missions which require coherency, a turnaround frequency ratio must be defined;
- (c) that some CCSDS agencies have used the 749/880 turnaround ratio for several years and others are planning its use for the near future;
- (d) that some CCSDS agencies have developed equipment using this ratio for their spacecraft and Earth stations and others are planning to do so in the near future, representing a large financial investment;
- (e) that the 749/880 turnaround frequency ratio adequately translates the 7145 - 7235 MHz band to the 8400 - 8500 MHz band;

recommends

- (1) that CCSDS agencies use the 749/880 turnaround frequency ratio for their Category A and Category B space missions operating in the 7145 - 7235 and 8400 - 8500 MHz bands;
- (2) that this turnaround frequency ratio is only necessary for those space missions which require both cross support from other agencies' Earth stations and coherency between the Earth-to-space and space-to-Earth links.

Earth Stations and Spacecraft

**2.6.3A TRANSPONDER TURNAROUND FREQUENCY RATIOS FOR THE
2025 — 2110 MHz AND 8450 — 8500 MHz BANDS, CATEGORY A**

The CCSDS,

considering

- (a) that future Category A space missions will use Earth-to-space links in the 2025 - 2110 MHz band in conjunction with space-to-Earth links in the 8450 - 8500 MHz band;
- (b) that these space missions may require coherency between the Earth-to-space and space-to-Earth links for the development of navigational data;
- (c) that for space missions which require coherency, a turnaround frequency ratio must be defined;
- (d) that the two frequency bands under consideration differ regarding the available bandwidth;
- (e) that the lower and upper parts of the 2025-2110 MHz band are already rather densely occupied by long term missions and, consequently, they should be avoided;
- (f) that for reasons of standardization of the on-board receiver design, a ratio between the two bands under consideration should be chosen in such a way as to conserve the number “221” of the “221/240” ratio for 2 GHz downlink/uplink systems;
- (g) that for reasons of simplicity of on-board transmitter design, a ratio which can be divided down to small integers should be selected;

recommends

- (1) that CCSDS agencies use a turnaround frequency ratio of 221/900 for systems operating in the 2075 - 2087 MHz and 8450 - 8500 MHz bands;
- (2) that this turnaround frequency ratio is only necessary for those space missions which require both cross support from other agencies' Earth stations and coherency between the Earth-to-space and space-to-Earth links.

Earth Stations and Spacecraft

**2.6.4A TRANSPONDER TURNAROUND FREQUENCY RATIOS FOR THE
7190 — 7235 MHz AND 2200 — 2290 MHz BANDS, CATEGORY A**

The CCSDS,

considering

- (a) that future Category A space missions will use Earth-to-space links in the 7190 - 7235 MHz band in conjunction with space-to-Earth links in the 2200 - 2290 MHz band;
- (b) that these space missions may require coherency between Earth-to-space and space-to-Earth links for the development of navigational data;
- (c) that for space missions which require coherency, a turnaround frequency ratio must be defined;
- (d) that the two frequency bands under consideration differ regarding the available bandwidth;
- (e) that the lower and upper parts of the 2200 - 2290 MHz band are already rather densely occupied by long term missions and, consequently, they should be avoided;
- (f) that in many cases, the 2 GHz transponder will not be modified, and the 7 GHz Earth-to-space link can be considered as optional;
- (g) that a design goal of the 2/8 GHz transponder should be a simplicity of interfaces and system flexibility;
- (h) that similarity of the circuit layout with the transponders developed for the deep space frequency bands may make hardware reuse possible;

recommends

- (1) that CCSDS agencies use a turnaround frequency ratio of 765/240 for systems operating in the 7190 - 7235 MHz and 2256 - 2270 MHz bands;
- (2) that this turnaround frequency ratio is only necessary for those space missions which require both cross support from other agencies' Earth stations and coherency between the Earth-to-space and space-to-Earth links.

Earth Stations and Spacecraft

**2.6.5B TRANSPONDER TURNAROUND FREQUENCY RATIOS FOR THE
2110 — 2120 MHz AND 8400 — 8450 MHz BANDS, CATEGORY B**

The CCSDS,

considering

- (a) that Category B space missions use Earth-to-space links in the 2110 - 2120 MHz band in conjunction with space-to-Earth links in the 8400 - 8500 MHz band;
- (b) that many of these space missions require coherency between the Earth-to-space and space-to-Earth links for the development of navigational data;
- (c) that for space missions which require coherency, a turnaround frequency ratio must be defined;
- (d) that for reasons of standardization of the on-board receiver design, a ratio between the two bands under consideration should be chosen in such a way as to conserve the number "221" of the "221/240" ratio for 2 GHz uplink/downlink systems;
- (e) that for reasons of simplicity of on-board transmitter design, a ratio which can be divided down to small integers should be selected;
- (f) that some CCSDS agencies utilize a turnaround frequency ratio of 221/880 and others are planning to do so in the near future;

recommends

- (1) that CCSDS agencies use a turnaround frequency ratio of 221/880 for their Category B missions operating in the 2110 - 2120 MHz and 8400 - 8450 MHz bands;
- (2) that this turnaround frequency ratio is only necessary for those space missions which require both cross support from other agencies' Earth stations and coherency between the Earth-to-space and space-to-Earth links.

Earth Stations and Spacecraft

**2.6.6B TRANSPONDER TURNAROUND FREQUENCY RATIOS FOR THE
7145 — 7190 MHz AND 2290 — 2300 MHz BANDS, CATEGORY B**

The CCSDS,

considering

- (a) that Category B space missions will use Earth-to-space links in the 7145 - 7190 MHz band in conjunction with space-to-Earth links in the 2290 - 2300 MHz band;
- (b) that many of these space missions require coherency between the Earth-to-space and space-to-Earth links for the generation of navigational data;
- (c) that for space missions which require coherency, a turnaround frequency ratio must be defined;
- (d) that for reasons of standardization of on-board receiver design, a turnaround frequency ratio containing the number "749" of the "749/880" ratio for the 7 GHz uplink/8 GHz downlink systems should be selected;
- (e) that for reasons of standardization of on-board transmitter design, a turnaround frequency ratio containing the number "240" of the "221/240" ratio for 2 GHz uplink/downlink systems should be selected;

recommends

- (1) that CCSDS agencies use a turnaround frequency ratio of 749/240 for Category B missions operating in the 7145 - 7190 MHz and 2290 - 2300 MHz bands;
- (2) that this turnaround frequency ratio is only necessary for those space missions which require both cross support from other agencies' Earth stations and coherency between the Earth-to-space and space-to-Earth links.

Earth Stations and Spacecraft

**2.6.7B TRANSPONDER TURNAROUND FREQUENCY RATIOS FOR THE
7145 — 7190 MHz AND 31.8 — 32.3 GHz BANDS, CATEGORY B**

The CCSDS,

considering

- (a) that many Category B space missions will use Earth-to-space links in the 7145-7190 MHz band in conjunction with space-to-Earth links in the 31.8-32.3 GHz band;
- (b) that many of these space missions require coherency between the Earth-to-space and space-to-Earth links for the generation of navigation data;
- (c) that for space missions which require coherency, a Transponder Turnaround Frequency Ratio (TTFR) that provides a maximum number of coherent channels must be defined;
- (d) that three turnaround ratios are needed to allow almost full access of the entire 31.8-32.3 GHz band while maintaining coherency between the space-to-Earth link and the Earth-to-space link in the 7145-7190 MHz band;
- (e) that for reasons of standardization, of the on-board receiver design, a TTFR should be chosen in such a way as to conserve 749 as the numerator of the ratio for the 7 GHz uplink / 32 GHz downlink system;
- (f) that an odd number (749) has been selected as the uplink factor (numerator of the TTFR) and an even number should be selected as the downlink factor (denominator of the TTFR) to prevent downlink harmonic interference with uplink signals;
- (g) that, if the denominator of the TTFR can be factored into small prime numbers, e.g., ≤ 19 , then conventional frequency multiplying devices, followed by band-pass filters, can be easily implemented;
- (h) that, if the denominator of the TTFR can be factored into small prime numbers, it offers designers implementation flexibility;
- (i) that a denominator of the TTFR of 3344 has been recommended by CCSDS and implemented on some transponders;
- (j) that a denominator of the TTFR of 3360 has been implemented on at least one transponder and is being implemented on another;
- (k) that a denominator of the TTFR of 3328 would complement the 3344 and 3360 denominators to allow almost full access of the 31.8-32.3 GHz band;
- (l) that existing Earth stations for Category B missions capable of receiving 31.8-32.3 GHz band can readily support multiple transponder turnaround ratios;

recommends

that CCSDS Agencies use the following Transponder Turnaround Frequency Ratios for Category B missions operating in the 7145-7190 MHz and the 31.8-32.3 GHz bands:

749/3328; 749/3344; and 749/3360.

Earth Stations and Spacecraft

**2.6.8B TRANSPONDER TURNAROUND FREQUENCY RATIOS FOR THE
31.8 — 32.3 GHz AND 34.2 — 34.7 GHz BANDS, CATEGORY B**

The CCSDS,

considering

- (a) that Category B space missions use Earth-to-space links in the 34.2-34.7 GHz band in conjunction with space-to-Earth links in the 31.8-32.3 GHz band;
- (b) that many of these space missions require coherency between the Earth-to-space and space-to-Earth links for the generation of navigation data;
- (c) that for space missions which require coherency, a Transponder Turnaround Frequency Ratio (TTFR) that provides a maximum number of coherent channels must be defined;
- (d) that for reasons of standardization, of the on-board receiver design, a TTFR should be chosen in such a way as to conserve 3344 as the denominator of the ratio for the 34 GHz uplink / 32 GHz downlink system;¹
- (e) that an odd number is selected as the uplink factor (numerator of the TTFR) and an even number is selected as the downlink factor (denominator of the TTFR) to prevent downlink harmonic interference with uplink signals;
- (f) that, if the denominator of the TTFR can be factored into prime numbers ≤ 19 , then conventional frequency multiplying devices, followed by band-pass filters, can be implemented;
- (g) that, if the difference between the numerator and the denominator of the TTFR can be factored into prime numbers ≤ 19 , then conventional frequency multiplying devices, followed by band-pass filters, can be implemented;
- (h) that the number of frequency multipliers should be reduced to minimize the delay in the spacecraft receiver's closed phase-locked-loop path;
- (i) that the denominator of the TTFR should be chosen to allow maximum Voltage Controlled Oscillator (VCO), Automatic Gain Control (AGC), and Diplexer implementation flexibility;
- (j) that the denominator of the TTFR should be chosen to generate a minimum number channels that fall into the *Inter-Satellite Service* allocation in the 32-33 GHz band;
- (k) that many Category B space missions carry both X-band and Ka-band transponders and that sharing of transponder hardware and implementation simplicity are desirable;

recommends

that CCSDS Agencies use one of the following Transponder Turnaround Frequency Ratios, 3599/3344 and 3599/3360, for Category B missions operating in the 34.2-34.7 GHz and the 31.8-32.3 GHz bands.

NOTE:

1. See CCSDS Recommendations 401 (2.6.7) B-1.

Earth Stations and Spacecraft

2.6.9A TRANSPONDER TURNAROUND FREQUENCY RATIOS FOR THE 7190 – 7235 MHz AND 25.5 – 27.0 GHz BANDS, CATEGORY A

The CCSDS,

considering

- (a) that future space missions can use Earth-to-space links in the 7190-7235 MHz band in conjunction with space-to-Earth links in the 25500-27000 MHz band;
- (b) that these space missions may require coherency between Earth-to-space and space-to-Earth links for development of navigational data;
- (c) that for space missions which require coherency, a transponder turnaround frequency ratio (TTFR) must be defined;
- (d) that the two frequency bands under consideration differ greatly regarding the available bandwidth, and consequently will require many turnaround ratios;
- (e) that for reasons of standardization of on-board receiver design, a transponder turnaround frequency ratio containing the number “749” in the numerator should be selected to be consistent with the existing TTFR recommendation for the 7145-7235 MHz and 8400-8500 MHz bands;¹
- (f) that an odd number (749) has been selected as an uplink factor (numerator of the TTFR), and thus an even number should be selected as the denominator of the TTFR to prevent downlink harmonic interference with uplink signals;
- (g) that for reasons of simplicity of on-board transmitter, turnaround ratios whose numerators and denominators can be factored into a minimum set of small integers are preferable;

recommends

- (1) that CCSDS agencies use turnaround frequency ratios in Table 2.6.9A-1 for systems operating in the 7190-7235 MHz and 25500-27000 MHz bands;
- (2) that these turnaround frequency ratios are only necessary for those space missions which require both cross support from other agencies’ Earth stations and coherency between the Earth-to-space and space-to-Earth links.

¹ See CCSDS Recommendation 401 (2.4.2) B-2.

Earth Stations and Spacecraft

Table 2.6.9A-1: Turnaround Frequency Ratios for 7190-7235 MHz and 25.5-27.0 GHz Bands

Transponder Turnaround Frequency Ratio (E-S/S-E)	Allocated Earth-to-Space Band (MHz)	Available Earth-to-Space Coherent Band ² (MHz)	Allocated Space-to-Earth Band (MHz)	Available Space-to-Earth Coherent Band ² (MHz)
749/2652	7190 – 7235	7201.923 – 7235	25500 – 27000	25500.000-25617.116
749/2662	7190 – 7235	7190 – 7235	25500 – 27000	25553.778-25713.712
749/2678	7190 – 7235	7190 – 7235	25500 – 27000	25707.370-25868.264
749/2688	7190 – 7235	7190 – 7235	25500 – 27000	25803.364-25967.860
749/2704	7190 – 7235	7190 – 7235	25500 – 27000	25956.996-26119.413
749/2720	7190 – 7235	7190 – 7235	25500 – 27000	26110.547-26273.965
749/2736	7190 – 7235	7190 – 7235	25500 – 27000	26264.139-26428.518
749/2754	7190 – 7235	7190 – 7235	25500 – 27000	26436.929-26602.390
749/2772	7190 – 7235	7190 – 7235	25500 – 27000	26609.720-26776.262
749/2784	7190 – 7235	7190 – 7235	25500 – 27000	26724.913-26892.176
749/2800	7190 – 7235	7190 – 7222.5	25500 – 27000	26878.505-27000.000

² The available coherent band refers to the range of frequencies which are coherent with the corresponding Earth-to-space or space-to-Earth band in the opposite direction.

Earth Stations and Spacecraft

2.6.10A TRANSPONDER TURNAROUND FREQUENCY RATIOS FOR THE 2025 – 2110 MHz AND 25.5 – 27.0 GHz BANDS, CATEGORY A

The CCSDS,

considering

- (a) that future space missions can use Earth-to-space links in the 2025-2110 MHz band in conjunction with space-to-Earth links in the 25500-27000 MHz band;
- (b) that these space missions may require coherency between Earth-to-space and space-to-Earth links for development of navigational data;
- (c) that for space missions which require coherency, a transponder turnaround frequency ratio (TTFR) must be defined;
- (d) that for reasons of standardization of on-board receiver design, a transponder turnaround frequency ratio containing the number “221” in the numerator should be selected to be consistent with the existing TTFR recommendation for the 2025-2110 MHz and 8450-8500 MHz bands;¹
- (e) that an odd number (221) has been selected as an uplink factor (numerator of the TTFR), and thus an even number should be selected as the denominator of the TTFR to prevent downlink harmonic interference with uplink signals;
- (f) that for reasons of simplicity of on-board transmitter, turnaround ratios whose numerators and denominators can be factored into a minimum set of small integers are preferable;
- (g) that since the uplink noise is amplified on the downlink by a factor equal to the squared turnaround frequency ratio, a high uplink signal-to-noise ratio may be needed for coherent operations;

recommends

- (1) that CCSDS agencies use turnaround frequency ratios in Table 2.6.10A-1 for systems operating in the 2025-2110 MHz and 25500-27000 MHz bands;
- (2) that these turnaround frequency ratios are only necessary for those space missions which require both cross support from other agencies’ Earth stations and coherency between the Earth-to-space and space-to-Earth links.

¹ See CCSDS Recommendation 401 (2.6.3A) B-1

Earth Stations and Spacecraft

Table 2.6.10A-1: Turnaround Frequency Ratios for 2025-2110 MHz and 25.5-27.0 GHz Bands

Transponder Turnaround Frequency Ratio (E-S/S-E)	Allocated Earth-to-Space Band (MHz)	Available Earth-to-Space Coherent Band ² (MHz)	Allocated Space-to-Earth Band (MHz)	Available Space-to-Earth Coherent Band ² (MHz)
221/2772	2025-2110	2033 – 2110	25500 – 27000	25500.000-26465.701
221/2850	2025-2110	2025 – 2094	25500 – 27000	26114.253-27000.000

² The available coherent band refers to the range of frequencies which are coherent with the corresponding Earth-to-space or space-to-Earth band in the opposite direction.

Earth Stations and Spacecraft

RESERVED FOR
RECOMMENDATION

2.6.11

14 — 17 GHz TRANSPONDER
TURNAROUND FREQUENCY RATIOS

Earth Stations and Spacecraft

**2.6.12 SPACECRAFT TRANSPONDER IF AND AGC AMPLIFIER BANDWIDTHS
FOR COHERENT OPERATION**

This recommendation has been deleted (CCSDS resolution CMC-R-2006-03-008).

Earth Stations and Spacecraft

3.0 POLICY RECOMMENDATIONS

Section 2 concerns itself with Recommendations pertaining to Radio Frequency and Modulation systems' technical characteristics. By contrast, this chapter focuses upon radio frequency spectrum usage.

Rules governing a user's operations in the frequency bands are as important as the equipment's technical specifications. As crowding of the RF spectrum increases, standards become an imperative to maintaining order. In a broad sense, the International Telecommunication Union (ITU) establishes high-level spectrum policy with its Radio Regulations. Here, the principal concern is to establish lower-level Recommendations promoting the most efficient use of the ITU's frequency allocations.

These policies are intended to supplement, not supplant, those promulgated by the ITU. This goal is reached by increasing the relevance of specific ITU regulations to spacecraft communications. Each Recommendation begins with applicable provisions of the ITU's Radio Regulations as a foundation and provides additional guidelines for that particular application.

By establishing the following agreements, the CCSDS agencies hope to significantly reduce spectrum congestion. Then, the potential for mutual interference in spacecraft communications should decrease accordingly.

A significant number of new Recommendations are concerned with *Policy*. Filing all such Recommendations in a single section makes them difficult to locate and promotes disorder. Accordingly, there are now six *Policy* sub-sections:

- | | | | |
|-----|------------------------------|-----|--------------------------------|
| 3.1 | <i>Frequency Utilization</i> | 3.4 | <i>Operational Procedures</i> |
| 3.2 | <i>Power Limitations</i> | 3.5 | <i>Testing Recommendations</i> |
| 3.3 | <i>Modulation Methods</i> | 3.6 | <i>Spacecraft Systems</i> |

These sub-sections are intended to be general categories into which *Policy* Recommendations can be filed and which will simplify a reader's task in locating specific items.

Earth Stations and Spacecraft

3.1.1 EFFICIENT UTILIZATION OF THE 2 GHz BANDS FOR SPACE OPERATION

The CCSDS,

considering

- (a) that the frequency bands 2025–2110 and 2200–2290 MHz are shared co-equally by the Space Research, Space Operation, and Earth Exploration Satellite Services;
- (b) that bands allocated to the Space Operation service may be used for space tracking, space telemetry, and space telecommand (TTC) by other space services;
- (c) that the definition of the Space Operation service (ITU-RR-1.23) postulates that these TTC activities by other space services normally be carried out in their service bands;
- (d) that the bands 2025–2110 and 2200–2290 MHz, which are already now densely occupied, are of prime importance for space science missions of CCSDS agencies and will remain so for many years to come as no comparable alternative frequency allocations are available;

recommends

that, in order to make maximum use of these bands for satellite missions of all kinds, appropriate technical and operational constraints be observed, particularly:

- i Geostationary space systems of space services other than the space science services¹ which are designed to operate in mission bands other than 2025–2110 and 2200–2290 MHz, but which utilize TTC systems within these bands, shall limit the use of such TTC systems to a single frequency pair per satellite and to launch, orbit insertion, and emergency operations.
- ii TTC systems for geostationary satellites of space services other than the space science services should be designed in accordance with the general characteristics as contained in Table 3.1.1-1.
- iii Non-geostationary satellites of services other than the space science services avoid using these bands for TTC.

¹ Space Science Services include the Space Research, Space Operations, Earth Exploration Satellite and Meteorological Satellite Services.

Earth Stations and Spacecraft

3.1.1 EFFICIENT UTILIZATION OF THE 2 GHz BANDS FOR SPACE OPERATION
(Continued)

TABLE 3.1.1-1

TYPICAL SYSTEM PARAMETERS FOR SPACE OPERATION OF
GEOSTATIONARY SATELLITES AT 2 GHz

MODE	SYSTEM PARAMETERS	
Reception at Earth station	Telemetry bandwidth	100 kHz
	Tracking bandwidth	400 kHz
	G/T, Earth stations	20 dB/K
Transmission from Earth stations	Telecommand bandwidth	100 kHz
	Tracking bandwidth	400 kHz
	EIRP, Earth station	65 dBW

Earth Stations and Spacecraft

**3.1.2A USE OF THE 8450 — 8500 MHz BAND FOR SPACE RESEARCH,
CATEGORY A**

The CCSDS,

considering

- (a) that the Radio Regulations permit the use of the 8450–8500 MHz band for Category A and Category B space missions;
- (b) that the band is one of only three primary allocations to the Space Research service below 40 GHz;
- (c) that the band, because of crowding at 2200–2290 MHz, is particularly suitable for distant missions such as to the Libration points;
- (d) that the 8400–8450 MHz band is allocated for and restricted to Category B missions;
- (e) that the 14.0–15.35 GHz and 37–38 GHz bands have been identified by SFCG¹ as appropriate for Category A missions requiring wide (greater than 10 MHz) bandwidth;

recommends

- (1) that the 8450–8500 MHz band be used for Category A missions requiring an occupied bandwidth of up to 10 MHz per mission;
- (2) that the band be used in particular for the missions to the Libration points with bandwidth requirements up to 10 MHz;
- (3) that utmost care be taken in the assignment of frequencies in this band in order to make optimum use of the limited bandwidth available to Category A missions and that the maximum bandwidth, postulated in *recommends (1)* be strictly respected;
- (4) that the 8450–8500 MHz band should not be used for Category B missions.

¹ See SFCG recommendation 5-1R5.

Earth Stations and Spacecraft

**3.1.2B USE OF THE 8400 — 8450 MHz BAND FOR SPACE RESEARCH,
CATEGORY B¹**

**The CCSDS,
considering**

- (a) that the 8400–8450 MHz band is allocated for and restricted to Space Research service, Category B, missions;
- (b) that users and data rates in the 8.4 GHz band continue to increase, and congestion in this band is more severe than in the 2 and 32 GHz bands;
- (c) that spacecraft in the Mars region are much more vulnerable to mutual interference because of lack of spatial separation, and that a single unrestricted high-rate mission could occupy the entire 50 MHz allocation in the 8.4 GHz band, preventing its use by any other user in the Mars region;
- (d) that five or six high rate missions could conceivably coexist in the Mars vicinity in the future, making it necessary to limit the maximum allowable bandwidth for each mission to no more than 8 MHz in the 8.4 GHz band;
- (e) that deep space missions designed for destinations other than Mars should also have restrictions on their maximum allowable bandwidths in the 8.4 GHz band, although at a less severe level since there is usually greater spatial separation between these missions;
- (f) that separating two missions at the point where their power spectral densities are each 25 dB below their own spectral peaks is generally sufficient to prevent mutual interference;
- (g) that an interference spectral power flux density of $-266 \text{ dB(W/Hz/m}^2\text{)}$ would, when received by a 70 meter antenna, be 16 dB below the noise floor of the receiving system and would raise the system temperature by only 0.1 dB;

recommends

- (1) that, in the 8400-8450 MHz band, the maximum allowable bandwidth (B25)¹ of telemetry signals be limited according to figure 3.1.2B-1², wherein
 - a) the lower curve applies to all missions;
 - b) a larger bandwidth (B25)¹ is available to the non-Mars-missions as defined by the upper curve, strictly on condition that they would not interfere with the Mars missions;
- (2) that, in the 8400-8450 MHz band, the spectral power flux density outside the maximum allowable bandwidth (B25)¹ be limited to $-266 \text{ dB(W/Hz/m}^2\text{)}$ on the surface of the Earth.

¹ See SFCG Recommendation 23-1 or latest version.

² For the purpose of this Recommendation, the Symbol Rate (R_s) is defined in figure 3.1.2B-2.

Earth Stations and Spacecraft

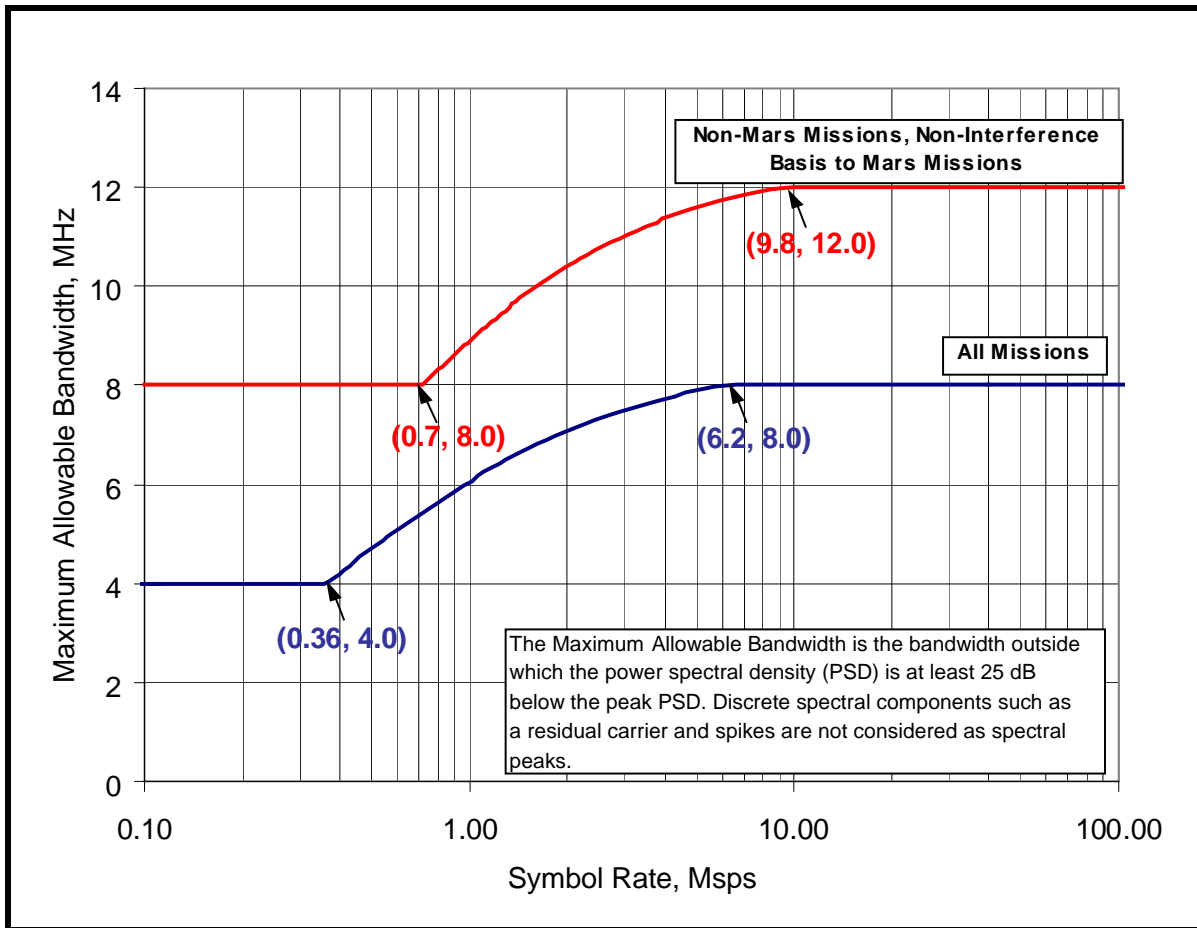

Figure 3.1.2B-1: Maximum Allowable Bandwidth (B25) vs. Symbol Rate (Rs) (in the Transition Regions, $B_{25} \text{ in MHz} = k * R_s / (0.41 + R_s)$ where $k=8.53$ and 12.5 for All-Missions and Non-Mars Missions, Respectively)

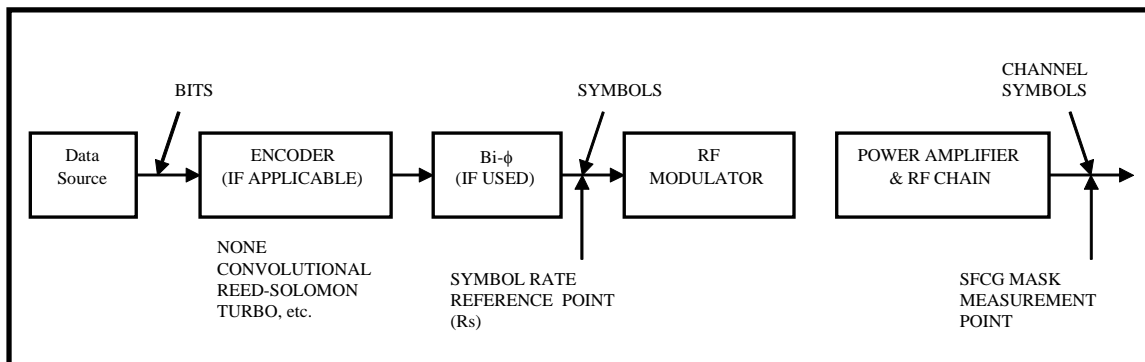

Figure 3.1.2B-2: Symbol Rate Definition

Earth Stations and Spacecraft

**3.1.3A USE OF THE 13.25 — 15.35 GHz BANDS FOR SPACE RESEARCH,
CATEGORY A**

This recommendation has been deleted (CCSDS resolution MC-S98-3).

Earth Stations and Spacecraft

3.1.4A CONSTRAINTS ON THE USE OF THE 14.0 - 15.35 GHz AND THE 16.6 - 17.1 GHz BANDS FOR SPACE RESEARCH, CATEGORY A

The CCSDS,

considering

- (a) that some missions operating in the *Space Research Service* require very large bandwidths (e.g., spaceborne VLBI, Geodesy, and Geodynamics);
- (b) that bandwidth requirements in excess of 10 MHz are increasingly difficult to satisfy in the frequency bands allocated to the *Space Research Service* below 10 GHz;
- (c) that the 8450-8500 MHz band has been determined to be inappropriate for Category A missions requiring more than 10 MHz bandwidth [see Recommendation 401 (3.1.2A) B-1];
- (d) that the 14.00-15.35 GHz band is densely occupied by the *Fixed Service* (14.30-15.35 GHz) and the Earth-to-space links of the *Fixed Satellite Service* (14.0-14.8 GHz), consequently, assignment of Earth-to-space links for the *Space Research Service* is difficult;
- (e) that the 16.6-17.1 GHz band is allocated to the *Radiolocation Service* (primary), and to the *Space Research Service* (deep space, Earth-to-space, secondary);
- (f) that CCSDS Agencies currently have no plans to use the 16.6-17.1 GHz band for deep space missions operating in the *Space Research Service*;
- (g) that the sharing situation in the 14.00-15.35 GHz and the 16.6-17.1 GHz bands, where the *Space Research Service* has only secondary status, is difficult and does not lend itself to the use of classical modulation schemes which exhibit a high interference potential and which have a high susceptibility to interference;
- (h) that spectrum spreading modulation methods can considerably alleviate the sharing problems noted above;
- (i) that CCSDS Agencies should ensure compatibility between their operations in the 14.00-15.35 GHz and the 16.6-17.1 GHz bands;
- (j) that certain parts of the 14.00-15.35 GHz band have existing and planned assignments to data relay satellite (Earth-to-space and space-to-space);

recommends

- (1) that the 14.00-15.35 GHz band be used for space-to-Earth transmissions of Category A missions operating in the *Space Research Service*;¹

NOTE:

- 1. The 14.3-14.4 GHz and the 14.47-14.50 GHz bands are not allocated to *Space Research Service* and will have to be used in accordance with the provisions of RR 342.

Earth Stations and Spacecraft

3.1.4A CONSTRAINTS ON THE USE OF THE 14.0 - 15.35 GHz AND THE 16.6 - 17.1 GHz BANDS FOR SPACE RESEARCH, CATEGORY A (Continued)

- (2) that the 16.6-17.1 GHz band be used for Earth-to-space transmissions of Category A missions operating in the *Space Research Service*;
- (3) that the spectrum of data transmissions in these bands be sufficiently spread so as to ensure adequate protection for services operating in the band;
- (4) that existing and planned frequency assignments for data relay satellites operating in the 14.00-15.35 GHz band be protected.

Earth Stations and Spacecraft

**3.1.5B USE OF THE 31.8 — 34.7 GHz BANDS FOR SPACE RESEARCH,
CATEGORY B**

This recommendation has been deleted (CCSDS resolution MC-S98-3).

Earth Stations and Spacecraft

3.1.6B CHANNEL FREQUENCY PLAN FOR 2, 7, 8, 32, AND 34 GHZ, CATEGORY B

The CCSDS,

considering

- (a) that channel frequency plans for Category B missions exist for the 2, 7, 8, 32, and 34 GHz bands;
- (b) that the sets of channel frequency pairs in these existing plans are based upon the recommended turnaround ratios;
- (c) that members of the Space Frequency Coordination Group (SFCG) have resolved to select frequencies for their Category B missions from the existing channel frequency plans;
- (d) that most past, existing, and planned Category B missions have assigned frequencies that were selected on the basis of these existing channel frequency plans;
- (e) that CCSDS agencies conducting Category B missions have coordinated the selection of frequencies from those embodied in the existing channel frequency plans in order to avoid interference between missions;

recommends

- (1) that CCSDS agencies select frequencies for their Category B missions operating in the 2, 7, 8, 32, and 34 GHz bands from the channel frequency plan contained in Table 3.1.6B-1;
- (2) that frequency selection be coordinated with an appropriate organization, such as the SFCG, to ensure the orderly use of the channel frequency plan.

TABLE 3.1.6B-1 - Channel Frequencies for Category B (Deep-Space) Missions

BAND (GHz):	2 E-S	2 S-E	7 E-S	8 S-E	32 S-E	32 S-E	32 S-E	34 E-S
FACTOR:	221	240	749	880	3328	3344	3360	3599
CHANNEL	F2DN							
1	* 2108.878858	2290.185185	7147.286265	* 8397.345679	#31757.234568	# 31909.913580	#32062.592592	# 34343.235339
2	* 2109.219908	2290.555556	7148.442132	* 8398.703706	#31762.370379	# 31915.074083	#32067.777787	# 34348.789361
3	* 2109.560957	2290.925926	7149.597994	8400.061729	#31767.506176	# 31920.234571	#32072.962966	# 34354.343368
4	* 2109.902006	2291.296296	7150.753857	8401.419752	#31772.641973	# 31925.395059	#32078.148146	# 34359.897374
5	2110.243056	2291.666667	7151.909724	8402.777780	31777.777784	31930.555562	32083.333340	34365.451396
6	2110.584105	2292.037037	7153.065587	8404.135803	31782.913581	31935.716050	32088.518519	34371.005402
7	2110.925154	2292.407407	7154.221450	8405.493826	31788.049378	31940.876538	32093.703699	34376.559408
8	2111.266204	2292.777778	7155.377316	8406.851853	31793.185190	31946.037042	32098.888893	34382.113431
9	2111.607253	2293.148148	7156.533179	8408.209876	31798.320986	31951.197530	32104.074073	34387.667437
10	2111.948303	2293.518519	7157.689045	8409.567903	31803.456798	31956.358033	32109.259267	34393.221460
11	2112.289352	2293.888889	7158.844908	8410.925927	31808.592595	31961.518521	32114.444447	34398.775466
12	2112.630401	2294.259259	7160.000771	8412.283950	31813.728392	31966.679009	32119.629626	34404.329472
13	2112.971451	2294.629630	7161.156637	8413.641977	31818.864203	31971.839512	32124.814821	34409.883494
14	2113.312500	2295.000000	7162.312500	8415.000000	31824.000000	31977.000000	32130.000000	34415.437500
15	2113.653549	2295.370370	7163.468363	8416.358023	31829.135797	31982.160488	32135.185179	34420.991506
16	2113.994599	2295.740741	7164.624229	8417.716050	31834.271608	31987.320991	32140.370374	34426.545528
17	2114.335648	2296.111111	7165.780092	8419.074073	31839.407405	31992.481479	32145.555553	34432.099534
18	2114.676697	2296.481481	7166.935955	8420.432097	31844.543202	31997.641967	32150.740733	34437.653540
19	2115.017747	2296.851852	7168.091821	8421.790124	31849.679014	32002.802470	32155.925927	34443.207563
20	2115.358796	2297.222222	7169.247684	8423.148147	31854.814810	32007.962958	32161.111107	34448.761569
21	2115.699846	2297.592593	7170.403550	8424.506174	31859.950622	32013.123462	32166.296301	34454.315592

Note – Channel frequencies marked “ * ” are not within the Category B band allocation.

Channel frequencies marked “ # ” may be used in conjunction with the corresponding channel in a lower frequency band if that channel is not marked by “ * ”.

F2DN = $N(10/27) + 2295$ MHz, where N is in the range -13 to +28 for this Table. The value of F2DN is rounded to the nearest Hz. Frequencies in the 2 GHz E-S band are then computed and rounded to the nearest Hz. Channel numbers are equal to N + 14. Frequencies in other bands are derived from the 2 GHz E-S frequencies by using the corresponding ratio of frequency factors, and then rounding to the nearest Hz.

TABLE 3.1.6B-1 (continued): Channel Frequencies for Category B (Deep-Space) Missions

BAND (GHZ):	2 E-S	2 S-E	7 E-S	8 S-E	32 S-E	32 S-E	32 S-E	34 E-S
FACTOR:	221	240	749	880	3328	3344	3360	3599
CHANNEL	F2DN							
22	2116.040895	2297.962963	7171.559413	8425.864197	31865.086419	32018.283950	32171.481481	34459.869598
23	2116.381944	2298.333333	7172.715276	8427.222220	31870.222216	32023.444438	32176.666660	34465.423604
24	2116.722994	2298.703704	7173.871143	8428.580248	31875.358027	32028.604941	32181.851854	34470.977626
25	2117.064043	2299.074074	7175.027006	8429.938271	31880.493824	32033.765429	32187.037034	34476.531632
26	2117.405092	2299.444444	7176.182868	8431.296294	31885.629621	32038.925917	32192.222213	34482.085639
27	2117.746142	2299.814815	7177.338735	8432.654321	31890.765432	32044.086420	32197.407408	34487.639661
28	2118.087191	* 2300.185185	7178.494597	8434.012344	#31895.901229	# 32049.246908	#32202.592587	# 34493.193667
29	2118.428241	* 2300.555556	7179.650463	8435.370371	#31901.037041	# 32054.407411	#32207.777782	# 34498.747689
30	2118.769290	* 2300.925926	7180.806327	8436.728395	#31906.172838	# 32059.567899	#32212.962961	# 34504.301695
31	2119.110339	* 2301.296296	7181.962190	8438.086418	#31911.308634	# 32064.728387	#32218.148140	# 34509.855701
32	2119.451389	* 2301.666667	7183.118056	8439.444445	#31916.444446	# 32069.888891	#32223.333335	# 34515.409724
33	2119.792438	* 2302.037037	7184.273919	8440.802468	#31921.580243	# 32075.049379	#32228.518514	# 34520.963731
34	* 2120.133487	* 2302.407407	7185.429782	8442.160491	#31926.716040	# 32080.209867	#32233.703694	# 34526.517737
35	* 2120.474537	* 2302.777778	7186.585648	8443.518518	#31931.851851	# 32085.370370	#32238.888888	# 34532.071759
36	* 2120.815586	* 2303.148148	7187.741511	8444.876542	#31936.987648	# 32090.530858	#32244.074068	# 34537.625765
37	* 2121.156636	* 2303.518519	7188.897377	8446.234569	#31942.123460	# 32095.691361	#32249.259262	# 34543.179787
38	* 2121.497685	* 2303.888889	* 7190.053240	8447.592592	#31947.259256	# 32100.851849	#32254.444442	# 34548.733793
39	* 2121.838734	* 2304.259259	* 7191.209103	8448.950615	#31952.395053	# 32106.012337	#32259.629621	# 34554.287799
40	* 2122.179784	* 2304.629630	* 7192.364969	* 8450.308642	#31957.530865	# 32111.172840	#32264.814816	# 34559.841822
41	* 2122.520833	* 2305.000000	* 7193.520832	* 8451.666665	#31962.666662	# 32116.333328	#32269.999995	# 34565.395828
42	* 2122.861882	* 2305.370370	* 7194.676696	* 8453.024689	#31967.802458	# 32121.493816	#32275.185174	# 34570.949834

Note – Channel frequencies marked “ * ” are not within the Category B band allocation.

Channel frequencies marked “ # ” may be used in conjunction with the corresponding channel in a lower frequency band if that channel is not marked by “ * ”.

F2DN = N(10/27) + 2295 MHz, where N is in the range -13 to +28 for this Table. The value of F2DN is rounded to the nearest Hz. Frequencies in the 2 GHz E-S band are then computed and rounded to the nearest Hz. Channel numbers are equal to N + 14. Frequencies in other bands are derived from the 2 GHz E-S frequencies by using the corresponding ratio of frequency factors, and then rounding to the nearest Hz.

Earth Stations and Spacecraft

**3.2.1A LIMITATIONS ON EARTH-TO-SPACE LINK POWER LEVELS,
CATEGORY A**

The CCSDS,

considering

- (a) that spectral occupation of frequency bands used by space agencies is increasing rapidly;
- (b) that in many cases the same frequencies will be shared by several spacecraft;
- (c) that the 2025–2110 MHz band is also shared with space-to-space links from data relay satellites to user satellites, which are limited to relatively small power levels by the provisions of ITU-RR-21.16 and are consequently particularly susceptible to interference;
- (d) that excessive EIRP from Earth stations will make intra-service frequency sharing increasingly difficult and result in inefficient use of the radio frequency spectrum;
- (e) that excessive EIRP from Earth stations likewise unnecessarily complicates the coordination with terrestrial services and may in some cases increase the coordination area;
- (f) that the required EIRP from an Earth station is determined by P_c/N_o , E_b/N_o , and the minimum signal level required by the spacecraft receiver;

recommends

- (1) that CCSDS agencies limit the EIRP on the Earth-to-space links to that required for safe spacecraft operation by means of one or several of the following:
 - CCSDS agencies avoid, whenever practicable, using high power transmitters having a fixed output but instead adjust their transmitted power level to the minimum needed to meet project requirements;
 - CCSDS agencies obtain the required EIRP by using reasonable antenna diameters in order to reduce both sidelobe radiation and transmitter power (Guideline: antenna diameter/RF wavelength equal to or greater than 70);
 - CCSDS agencies make Recommendation ITU-R SA.509 a requirement in antenna specifications;
- (2) that spacecraft equipment designers endeavor to provide similar margins with regard to minimum P_c/N_o , minimum E_b/N_o and the minimum signal required by the spacecraft receiver.

Earth Stations and Spacecraft

3.3.1 OPTIMAL RANGING MODULATION WAVEFORMS FOR SIMULTANEOUS RANGING, TELECOMMANDING, AND TELEMETRY OPERATIONS

The CCSDS,

considering

- (a) that two-way transmissions are employed for making range measurements to a distant spacecraft;
- (b) that telecommand and telemetry signals are phase shift-keyed onto the subcarriers and then phase-modulated onto a sinusoidal residual RF carrier [see Recommendations 401 (2.1.1) B-1, 401 (2.4.3) B-1];
- (c) that telemetry signals may also be directly modulated on the RF carrier in conformance with Recommendation 401 (2.4.7) B-1;
- (d) that sine-wave subcarriers are recommended for the telecommand channel [see Recommendation 401 (2.2.2) B-1];
- (e) that sine-wave subcarriers are recommended for Category A missions' telemetry channels, and square-wave subcarriers are recommended for Category B missions' telemetry channels [see Recommendation 401 (2.4.3) B-1];
- (f) that, for simultaneous telecommand and ranging on the Earth-to-space link, the telecommand performance suffers some degradation due to command-ranging cross-modulation components;
- (g) that, for simultaneous telemetry and ranging on the space-to-Earth link, the telemetry performance may be degraded due to interference from the filtered versions of the uplink ranging, feed-through telecommand, cross-modulation components and noise;
- (h) that the timing offset due to different clocks between the telecommand and telemetry may cause serious telemetry bit error rate (BER) degradation;
- (i) that the telecommand BER performance is virtually identical for either sine wave or square wave ranging modulation;
- (j) that, for Category B missions, the telemetry BER performance is insensitive to the type of ranging waveforms used when operated simultaneously with the ranging on the space-to-Earth link;
- (k) that the use of a square-wave ranging signal makes the telemetry BER performance more susceptible to data-to-data interference (resulting from the timing offset due to different clocks between the telecommand and telemetry) than the sine-wave ranging;
- (l) that, for Category A missions, the telemetry BER performance is sensitive to the timing offset when operated simultaneously with either a square-wave or sine-wave ranging signal;
- (m) that for Category B missions, it is important to minimize the required transmitted power level on the space-to-Earth link;

Earth Stations and Spacecraft

3.3.1 OPTIMAL RANGING MODULATION WAVEFORMS FOR SIMULTANEOUS RANGING, COMMANDING, AND TELEMETRY OPERATIONS (Continued)

- (n) that for Category A missions, it is necessary to minimize the adjacent channels interference;
- (o) that the use of a sine-wave ranging signal will minimize the occupied bandwidth;

recommends

- (1) that, for Category B missions' Earth-to-space links, either a sine wave or a square wave ranging signal may be used when operated simultaneously with the telecommand;
- (2) that, for Category A missions' Earth-to-space links, sine wave ranging shall be used when operated simultaneously with the telecommand;
- (3) that, for Categories A and B missions' space-to-Earth links, sine wave ranging should be used when operated simultaneously with the telemetry.

Earth Stations and Spacecraft

**3.3.2A CRITERIA FOR USE OF DIRECT SEQUENCE SPREAD SPECTRUM
MODULATION, CATEGORY A**

The CCSDS,

considering

- (a) that frequency bands must often be shared between several users which can result in mutual interference;
- (b) that such mutual interference can result in significant link degradation or even unusable links for certain periods of time;
- (c) that spread spectrum systems can be designed to tolerate a high level of interference from other communications systems;
- (d) that, in some cases, spread spectrum modulation can assist in meeting the PFD limits set forth in the International Telecommunication Union's (*ITU Radio Regulations*);
- (e) that direct sequence spread spectrum systems can be designed to provide ranging measurements by using the spreading code which eliminates the need for a separate ranging signal;

recommends

- (1) that direct sequence spread spectrum modulation be used in any of the following cases:
 - where the intra-service sharing conditions are such that other modulation methods will not provide the required performance or mutual compatibility with other transmissions assigned to the same frequency band;
 - where the inter-service sharing conditions are such that the susceptibility to actual or potential interference from transmissions in other services assigned to the same frequency band cannot be kept within acceptable limits by other modulation methods;
 - where the power flux density limits, as set forth in the *ITU Radio Regulations, Article 21*, cannot be met using other methods;
- (2) that spread spectrum systems shall be designed to minimize unwanted emissions in the same allocated frequency band;
- (3) that unwanted emissions generated by spread spectrum systems shall conform with applicable protection criteria of radio communications services in other frequency bands.

Earth Stations and Spacecraft

3.3.3A PREFERRED MODULATION FORMATS FOR SUPPRESSED CARRIER SYSTEMS, CATEGORY A

The CCSDS,

considering

- (a) that efficient use of RF spectrum resources is becoming increasingly important;
- (b) that suppressed carrier systems are more bandwidth and power efficient than are residual carrier systems and OQPSK/QPSK modulations are more bandwidth efficient than BPSK;
- (c) that in a realistic channel OQPSK systems are less sensitive to non-linear channel effects than are QPSK systems;
- (d) that sync word detection hardware for phase ambiguity resolution is simpler in a OQPSK system than is the case with a QPSK system;
- (e) that QPSK and OQPSK systems are widely used modulation techniques in bandwidth limited systems;
- (f) that Recommendation 2.4.17A defines recommended bandwidth efficient modulation formats for high symbol rate (> 2 Ms/s) space-to-Earth transmissions from Category A missions in space research service bands;

recommends

- (1) that OQPSK modulation¹ is preferred in communications systems operating at frequencies where the available bandwidth is limited (e.g., in the 2 and 8 GHz bands) for medium rate symbol transmissions (≤ 2 Ms/s);
- (2) that CCSDS agencies refer to Recommendations 2.4.17A for recommended modulation formats for high symbol rate (> 2 Ms/s) transmissions.

¹ Subject to the constraints of SFCG recommendations 21-2R2 or latest version.

Earth Stations and Spacecraft

3.3.4 USE OF SUBCARRIERS ON SPACECRAFT TELEMETRY CHANNELS

This recommendation has been deleted (CCSDS resolution MC-E03-01).

Earth Stations and Spacecraft

3.4.1 SIMULTANEOUS TELECOMMAND, TELEMETRY, AND RANGING OPERATIONS

The CCSDS,

considering

- (a) that most space agencies use ranging measurements for spacecraft orbit or trajectory determination;
- (b) that precision range measurements are frequently required to meet the scientific objectives of the mission;
- (b) that the ranging data can yield scientific information about the medium and other physical phenomena;
- (d) that the value of the information obtained from the ranging measurement for scientific purposes is directly related to its accuracy;
- (e) that the Earth stations tend to be large, complex, and expensive to construct and to operate;
- (f) that it is desirable to minimize the amount of Earth station time required for the support of missions;
- (g) that the quantity of telecommands transmitted to a spacecraft may be sufficiently large that it is desirable to have simultaneous telecommand and ranging operations;
- (h) that telemetry transmissions are generally continuous and an interruption for ranging operations may result in the loss of valuable data;
- (i) that the amount and accuracy of ranging required for missions makes it desirable to preserve an ability for simultaneous telecommand, telemetry, and ranging operations;

recommends

that all CCSDS agencies design their spacecraft to permit simultaneous telecommand, telemetry, and ranging operations.

Earth Stations and Spacecraft

3.4.2 CHARGED PARTICLE MEASUREMENTS IN THE TELECOMMUNICATIONS PROPAGATION PATH

The CCSDS,

considering

- (a) that the telecommunication system's performance can be affected by the columnar content of charged particles in the propagation path;
- (b) that charged particles in the propagation path can result in errors in the range and range rate measurements reducing navigation accuracy;
- (c) that navigation accuracy requirements can be very high for some Category B missions;
- (d) that the four regions through which a telecommunications signal may pass which contain charged particles are: the Earth's ionosphere, the interplanetary medium, the planetary ionosphere, and the solar corona;
- (e) that the Sun-Earth-Probe (SEP) angle is important in selecting a means for measuring charged particles;
- (f) that geostationary satellites are not useful for measuring charged particle content for regions beyond the Earth's ionosphere;
- (g) that Differenced Range vs. Integrated Doppler (DRVID) only measures variations in the total columnar electron content;
- (h) that method(s) utilized for measuring the charged particle content in the propagation path depends upon the region involved;
- (i) that figure 3.4.2-1 shows alternative spacecraft tracking methods which provide information about charged particles in the propagation path;

recommends

- (1) that CCSDS agencies utilize the appropriate methods in Table 3.4.2-1 to measure charged particles in the propagation path for the specified operating modes;
- (2) that CCSDS agencies utilize the methods and signal sources in Table 3.4.2-2 to measure charged particles in the named regions and to correct the specified data.

3.4.2 CHARGED PARTICLE MEASUREMENTS IN THE TELECOMMUNICATIONS PROPAGATION PATH (Continued)

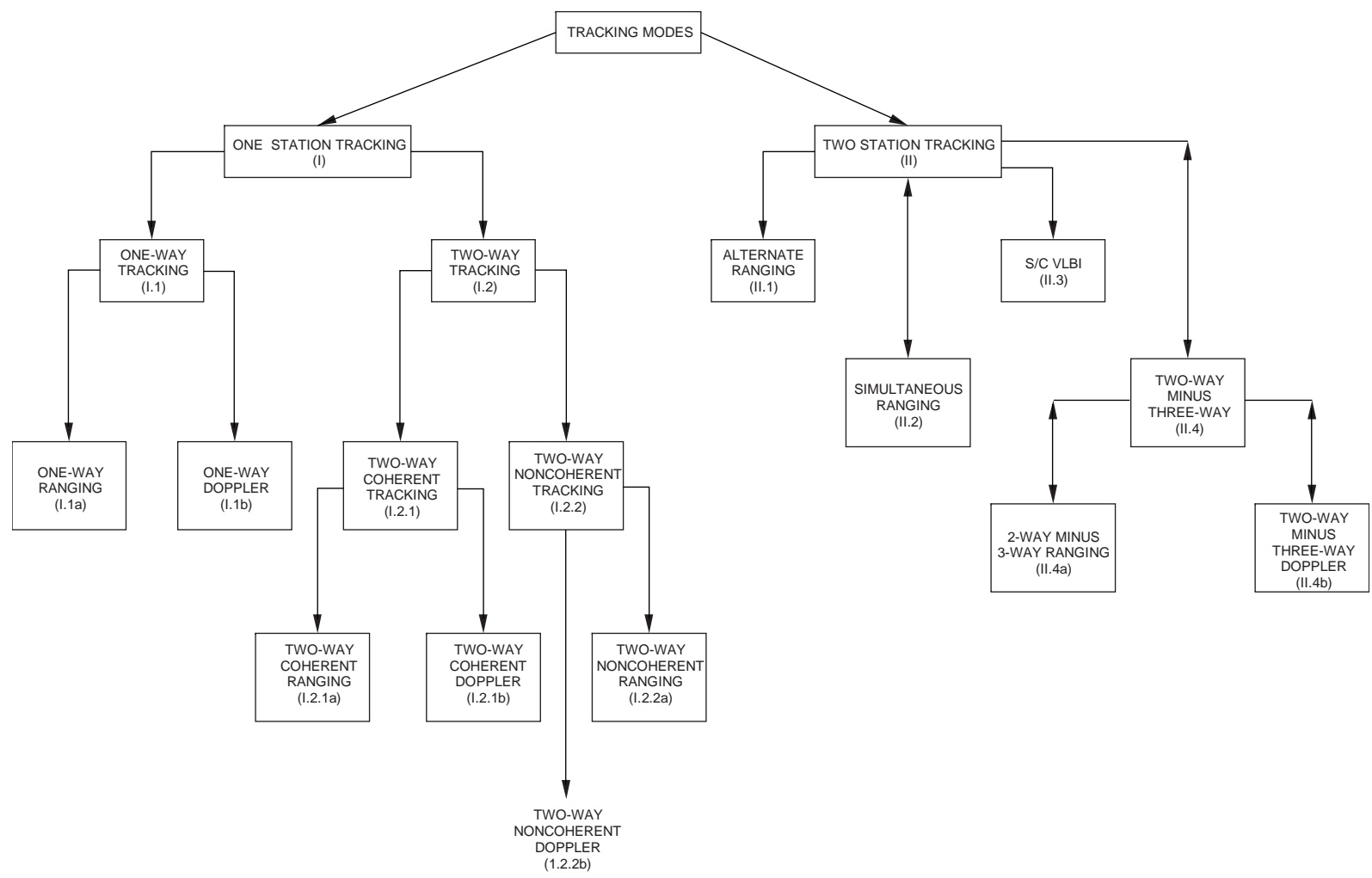

Figure 3.4.2-1: Possible Tracking Modes

Earth Stations and Spacecraft

3.4.2 CHARGED PARTICLE MEASUREMENTS IN THE TELECOMMUNICATIONS PROPAGATION PATH (Continued)

TABLE 3.4.2-1: RECOMMENDED CHARGED PARTICLE CALIBRATION METHODS

TRACKING MODE (see figure 3.4.2A-1)	FARADAY ROT		DRVID	DUAL FREQ		
	user s/c	geo sat	user s/c	user s/c	geo sat	slic ^(b)
I.1a (1-way range)	X	X		X	X	X
I.1b (1-way Doppler)	X	X	X	X	X	X
I.2.1a (2-way coh Rng)	X	X		X	X	X
I.2.1b (2-way coh Dop)	X	X	X	X	X	X
I.2.2a (2-way non-coh Rng)						
I.2.2b (2-way non-coh Dop)			X			
II.1 Alternate Rng	X	X		X	X	X
II.2 Simultaneous Rng	X	X		X	X	X
II.3 S/C VLBI	X	X		(a)		X
II.4a (2-way; 3-way Rng)	X	X		X	X	X
II.4b (2-way; 3-way Dop)	X	X	X	X	X	X

NOTES: (a) is applicable to 2/8 GHz downlink only.
(b) slic is satellite L-band ionospheric calibration.

TABLE 3.4.2-2: APPLICABILITY OF CALIBRATION METHODS

CALIBRATION METHOD	SOURCE USED	EARTH'S IONO-SPHERE	BEYOND IONO-SPHERE	RANGE ERROR	RANGE RATE ERROR
FARADAY ROTATION	S/C	X		X(1)	X(1)
	Geo Sat	X		X(2)	X(2)
DUAL FREQUENCY	S/C	X	X	X(3)	X(3)
	Geo Sat	X		X(2)	X(2)
	slic	X		X(2)	X(2)
DIFFERENCED RANGE vs. INTEGRATED DOP	S/C	X	X		
	Geo Sat				

NOTES: (1) should not be used for SEPs below 5 degrees.
(2) must translate ray path to user S/C line of sight.
(3) 2/8 GHz downlink only, inaccurate below SEP = 20 deg.

Earth Stations and Spacecraft

3.4.3A OPTIMAL CHARGED PARTICLE CALIBRATION TECHNIQUES FOR RANGING DATA UNDER VARIOUS PROPAGATION CONDITIONS, SINGLE STATION TRACKING, CATEGORY A

The CCSDS,
considering

- (a) that the Total (Columnar) Electron Content (TEC) in the telecommunications ray path may be a function of both the spacecraft-Earth station distance and the Sun-Earth-Probe (SEP) angle;
- (b) that, for Category A missions, the Round-Trip-Light-Time (RTLTL) is always less than or equal to 13.3 seconds;
- (c) that, for RTLTLs typically found with Category A missions, the TEC results primarily from the Earth's ionosphere and is substantially independent of SEP angle;
- (d) that for short telecommunications RTLTLs, the TEC is relatively invariant with time;
- (e) that, for Category A missions, the charged-particle environment can be assumed to be identical for both up and down links because of the short RTLTLs;
- (f) that it may be necessary to calibrate the TEC for Category A missions which have very high navigational or orbit positional accuracy requirements;
- (g) that charged particle calibration techniques such as dual frequency up/dual frequency down (or round-trip dual frequency), single frequency up/dual frequency down, and Faraday rotation can be used to calibrate the range data;
- (h) that, for Category A missions, use of the round-trip dual frequency technique does not offer any significant improvements in range error uncertainty when compared to a single frequency X-band (or higher) uplink/dual frequency downlink technique (see figure 3.4.3A-1);
- (i) that the use of Faraday Rotation technique may not provide the desired accuracy because it may require a mapping of total columnar electron content (TEC) to the line-of-sight for range error calibration;
- (j) that selection of the simplest qualified charged particle calibration technique should be based upon the (1) maximum permissible range error and RMS range error uncertainty, (2) minimum hardware requirements, and (3) requirement for a capability to calibrate the range data errors resulting from the variation of the total columnar electron content;

recommends

- (1) that space agencies use the single frequency up/dual frequency down technique to measure the TEC and then correct the range data;
- (2) that space agencies use the highest available frequency band for transmitting the single frequency uplink.

Earth Stations and Spacecraft

3.4.3A OPTIMAL CHARGED PARTICLE CALIBRATION TECHNIQUES FOR RANGING DATA UNDER VARIOUS PROPAGATION CONDITIONS, SINGLE STATION TRACKING, CATEGORY A (Continued)

ANNEX TO RECOMMENDATION

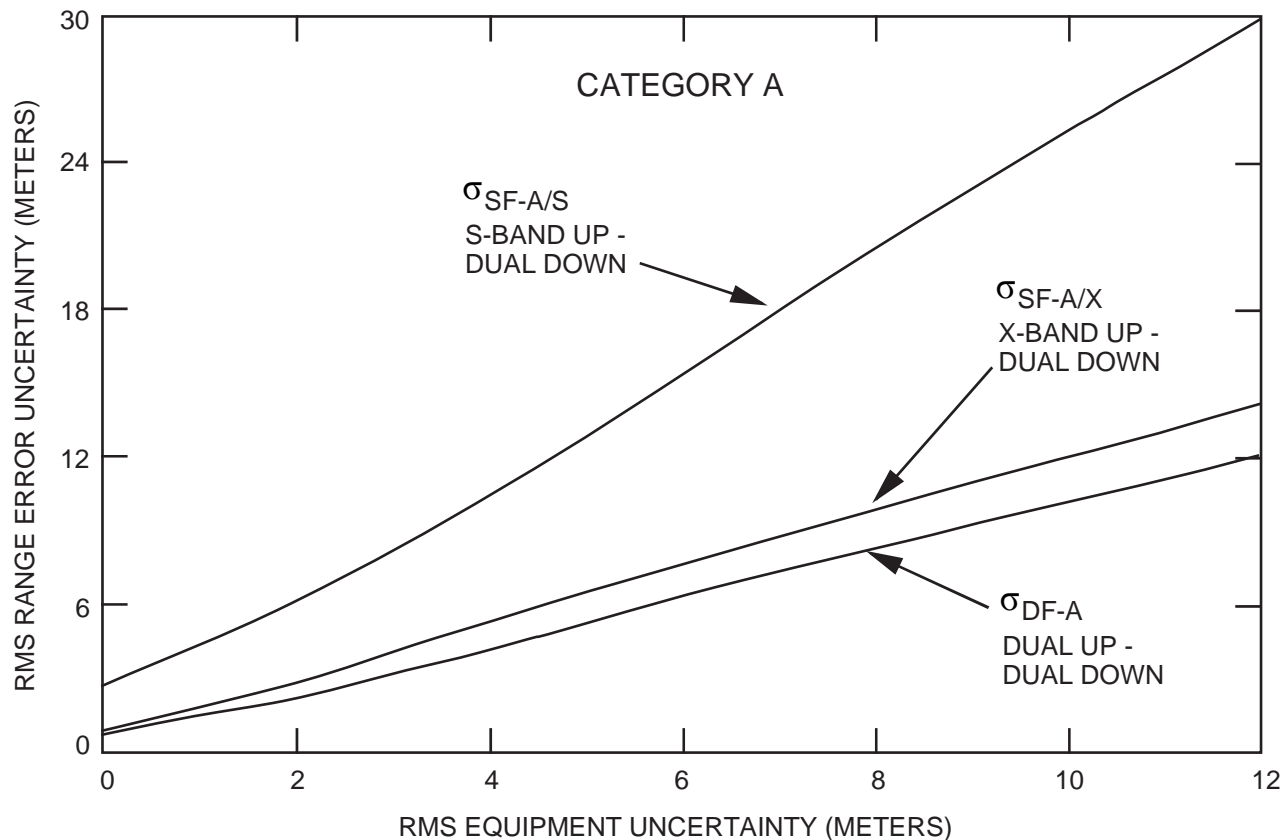

6445-445ab

Figure 3.4.3A-1: Ranging Accuracy versus RMS Equipment Uncertainty for Single Station, Category A¹

Legend

- $\sigma_{SF-A/S}$ = RMS range error uncertainty in meters for single frequency, S-Band up/dual frequencies S and X down for single station Category A missions.
- $\sigma_{SF-A/X}$ = RMS range error uncertainty in meters for single frequency X-Band up/dual frequency S and X down for single station Category A missions.
- σ_{DF-A} = RMS range error uncertainty in meters for dual frequency S and X up/dual frequency S and X down for single station Category A missions.

NOTE:

1. See Report of the Proceedings of the Subpanel 1E Meeting at the Ames Research Center, "Optimal Charged-Particle Calibration Technique for Ranging Data Channel," p 215, September 1989.

Earth Stations and Spacecraft

3.5.1 MINIMUM SET OF SPACECRAFT - EARTH STATION TESTS REQUIRED TO ENSURE COMPATIBILITY

The CCSDS,

considering

- (a) that cross support will frequently be required for Telemetry, Tracking, and/or Command operation;
- (b) that it is desirable to assure compatibility of the spacecraft with the ground network before the launch of a spacecraft;
- (c) that this compatibility is usually verified by compatibility tests;
- (d) that all parties have a common understanding of the tests;

recommends

that, in accordance with the required cross support, all relevant tests set forth in Table 3.5.1-1 shall be performed.

Earth Stations and Spacecraft

3.5.1 MINIMUM SET OF SPACECRAFT - EARTH STATION TESTS REQUIRED TO ENSURE COMPATIBILITY (Continued)

TABLE 3.5.1-1

TEST TYPES
<p style="text-align: center;">SPACECRAFT RADIO FREQUENCY</p> <p>Transmitter frequency and frequency stability Transmitter residual carrier phase jitter Transmitter RF spectrum measurement Receiver rest frequency determination Receiver acquisition frequency range and rate Receiver tracking frequency range and rate</p>
<p style="text-align: center;">TELEMETRY</p> <p>Telemetry modulation index Telemetry receiver carrier threshold Telemetry bit error rate Telemetry spectrum</p>
<p style="text-align: center;">TELECOMMAND</p> <p>S/C receiver command and carrier threshold S/C receiver telecommand phase modulation index variation Telecommand receiver spurious carrier immunity Telecommand receiver spurious modulation immunity</p>
<p style="text-align: center;">RANGING</p> <p>Transponder ranging delay Ranging downlink modulation index vs. uplink modulation index Ranging downlink spectrum Ranging downlink modulation index vs. uplink signal-to-noise power</p>
<p style="text-align: center;">EARTH STATION ANTENNA TRACKING SYSTEM</p> <p>Receiver carrier signal level threshold</p>

Earth Stations and Spacecraft

**3.6.1A INTERFERENCE REDUCTION IN THE 2200 - 2290 MHz BANDS,
CATEGORY A**

The CCSDS,

considering

- (a) that the planned increase in the number of links in the 2 GHz bands will raise the likelihood of harmful interference;
- (b) that channel coding techniques, such as the CCSDS concatenated codes, can reduce the power spectral density by more than 10 dB while lowering the susceptibility to interference;
- (c) that the use of suppressed carrier modulation techniques as recommended by the CCSDS, can further reduce the power spectral density;

recommends

that the power spectral density of space radiocommunication links be reduced by using appropriate modulation techniques and channel coding in accordance with CCSDS Recommendations in order to reduce the potential for harmful interference.

Earth Stations and Spacecraft

3.6.2A INTERFERENCE FROM SPACE-TO-SPACE LINKS BETWEEN NON-GEOSTATIONARY SATELLITES TO OTHER SPACE SYSTEMS IN THE 2025 - 2110 AND 2200 - 2290 MHz BANDS, CATEGORY A

The CCSDS,

considering

- (a) that space-to-space transmissions between two or more non-geostationary satellites shall not impose any constraints on other space transmissions (ITU-RR-5.392);
- (b) that the planned increase in the number of space-to-space links between non-geostationary satellites will raise the likelihood of harmful interference;

recommends

that the power spectral density of space-to-space links between any two non-geostationary satellites be reduced by using appropriate modulation techniques and channel coding in accordance with CCSDS Recommendations, in order to reduce the potential for harmful interference to space-to-Earth, Earth-to-space, and space-to-space transmissions involving at least one geostationary satellite.

Earth Stations and Spacecraft

4.0 PROCEDURAL RECOMMENDATIONS

As telecommunications systems become more sophisticated, it is imperative that aids be developed to assist in the design, performance evaluation, and perhaps even validation of these systems. Early on, the CCSDS was only concerned with technical Recommendations which promoted a uniformity in data systems. However, Subpanel 1E soon discovered that efficient use of the radio frequency spectrum was an imperative. Such efficient use implies constraints, and the first Blue Book included a *Policy* section. This section contained many Recommendations limiting CCSDS Agencies' use of radio frequencies beyond those already imposed by the ITU's Radio Regulations.

However, efficient use also implies optimal designs. The more efficiently a communications link can be made to operate, the more the frequency spectrum can be shared with other users. Use of the radio frequency bands is increasing so rapidly that sharing has become essential.

This section contains procedural Recommendations intended to assist the CCSDS Agencies to efficiently design and operate their telecommunications links. These Recommendations are, in effect, tools to optimize the design and performance of those links. Presently, Recommendations in this section will be found in two categories.

4.1 *Design Tools*

4.2 *Computational Algorithms*

However, it is likely that future Recommendations will also cover such areas as performance evaluation and validation.

Many of these tools can be most efficiently applied if they are in the form of computer programs. Work is underway to develop such programs for several Recommendations. These programs are being designed to run on small personal computers of the IBM AT class. Periodically, readers may wish to contact either the CCSDS Secretariat, or CCSDS Subpanel 1E members, to ascertain what programs are available.

Earth Stations and Spacecraft

4.1.1 SELECTION OF OPTIMUM MODULATION INDICES FOR SIMULTANEOUS RANGING, TELECOMMAND, AND TELEMETRY OPERATIONS

The CCSDS,

considering

- (a) that two-way transmissions are generally employed for making range measurements to a distant spacecraft;
- (b) that, for simultaneous telecommand and ranging on the Earth-to-space link, the telecommand performance may suffer some degradation due to telecommand-ranging cross-modulation components;
- (c) that, for simultaneous telemetry and ranging on the space-to-Earth link, the telemetry performance may be degraded due to interference from the filtered versions of the uplink ranging, feed-through telecommand, cross-modulation components and noise;
- (d) that the timing offset due to asynchronous clocks between the telecommand and telemetry may cause serious telemetry bit error rate (BER) degradation when the two subcarriers are not separated in frequency sufficiently;
- (e) that the performance degradation in the telecommand and telemetry due to the factors named in considerations in (b), (c) and (d) can be minimized if the modulation indices for telecommand, range, telemetry are chosen properly;
- (f) that the ranging receiver is usually not susceptible to interference from unwanted emissions which fall outside the receiver's bandwidth;
- (g) that the selected modulation indices will provide the optimum power division between the data (telecommand/telemetry) and the ranging channels for a required ranging accuracy, and a specified bit error rate degradation in the data channel;
- (h) that the selected modulation indices will result in adequate power for carrier tracking without degrading the specified data channel performance;
- (i) that the selected modulation indices will provide the required link performance margins for the carrier, range and data signals;

recommends

that the CCSDS agencies utilize the technique illustrated in Annex 1 and figure 4.1.1-1 to select the optimum set of modulation indices for simultaneous ranging, telecommand, and telemetry operations.

Earth Stations and Spacecraft

4.1.1 SELECTION OF OPTIMUM MODULATION INDICES FOR SIMULTANEOUS RANGING, TELECOMMAND, AND TELEMETRY OPERATIONS (Continued)

ANNEX 1

The constants A_1 , A_2 , A_3 , A_4 , A_5 , and the design factor K shown in figure 4.1.1-1 are defined as follows:

$$A_1 = \frac{(SNR)_D}{(SNR)_C}$$

$$A_2 = \frac{(SNR)_D}{(SNR)_R}$$

$$A_3 = \frac{(SNR)_R}{(SNR)_D} = \frac{1}{A_2}$$

$$A_4 = (SNR)_R$$

$$A_5 \text{ (dB)} = 10 \log_{10} [10^{\{\Delta_D(\text{dB})/10\}} - 1]$$

$$k = \left[\frac{(SNR)_R}{(SNR)_D} \right] \times \left[\frac{1}{\Delta_S} \right]$$

where:

Δ_D (dB) = Degradation in the Data Channel due to the interference from the ranging channel.

Δ_S (dB) = A_5 (dB) - $[(SNR)_{REQ} + P_I$ (dB)].

$(SNR)_{REQ}$ = Required data signal-to-noise ratio to achieved a desired bit error rate.

P_I = The maximum ranging channel power level which falls into the data channel.

$(SNR)_D$ = Threshold signal-to-noise power density ratio in the data channel.

$(SNR)_C$ = Threshold signal-to-noise power density ratio in the carrier channel.

$(SNR)_R$ = Threshold signal-to-noise power density in the ranging channel.

Earth Stations and Spacecraft

4.1.1 SELECTION OF OPTIMUM MODULATION INDICES FOR SIMULTANEOUS RANGING, TELECOMMAND, AND TELEMETRY OPERATIONS (Continued)

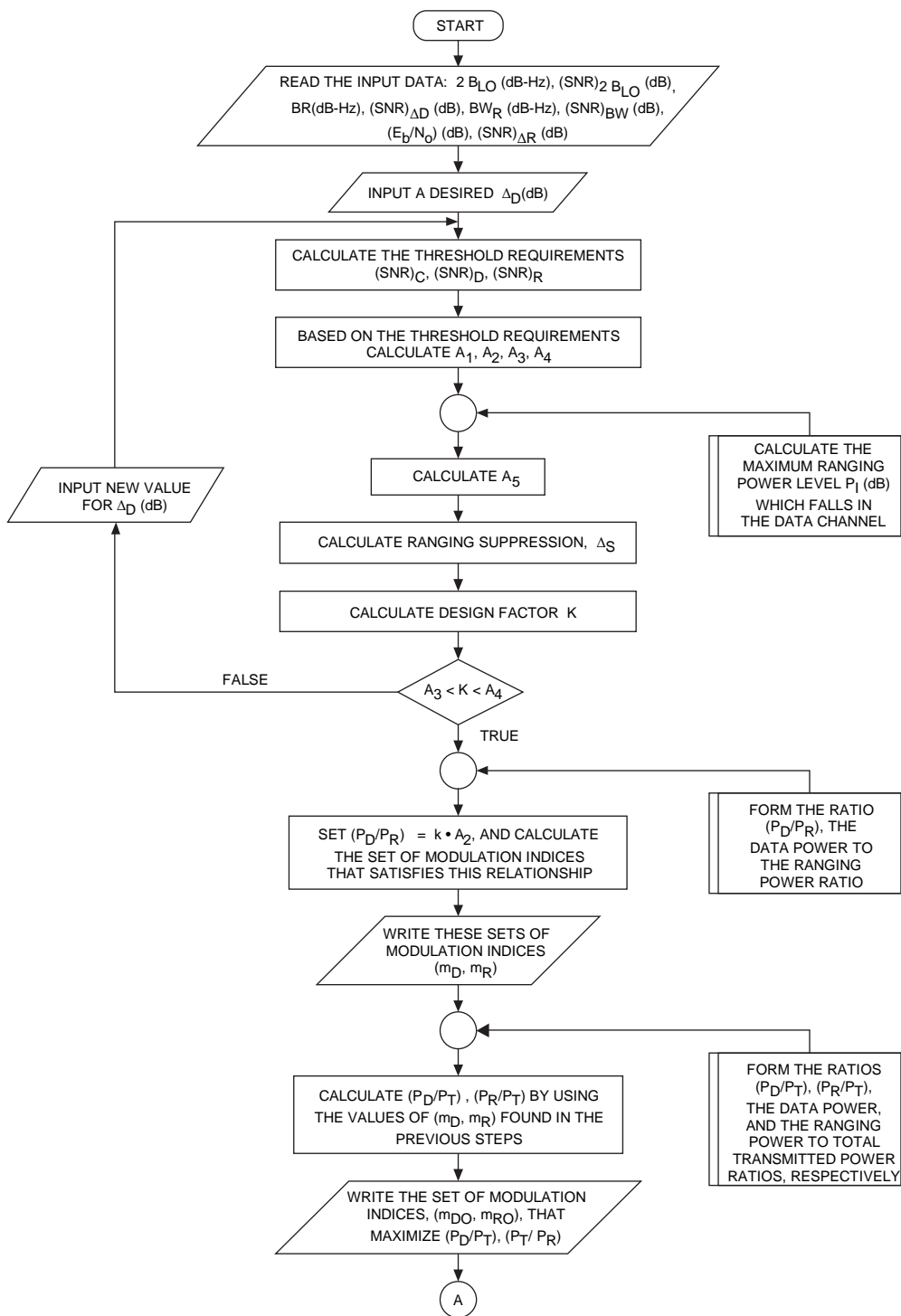

6485-23012An

Figure 4.1.1-1: MT's Algorithm: An Algorithm to Search for a Set of Optimum Modulation Indices for Simultaneous Command / Telemetry / Range Operations

Earth Stations and Spacecraft

4.1.1 SELECTION OF OPTIMUM MODULATION INDICES FOR SIMULTANEOUS RANGING, TELECOMMAND, AND TELEMETRY OPERATIONS (Continued)

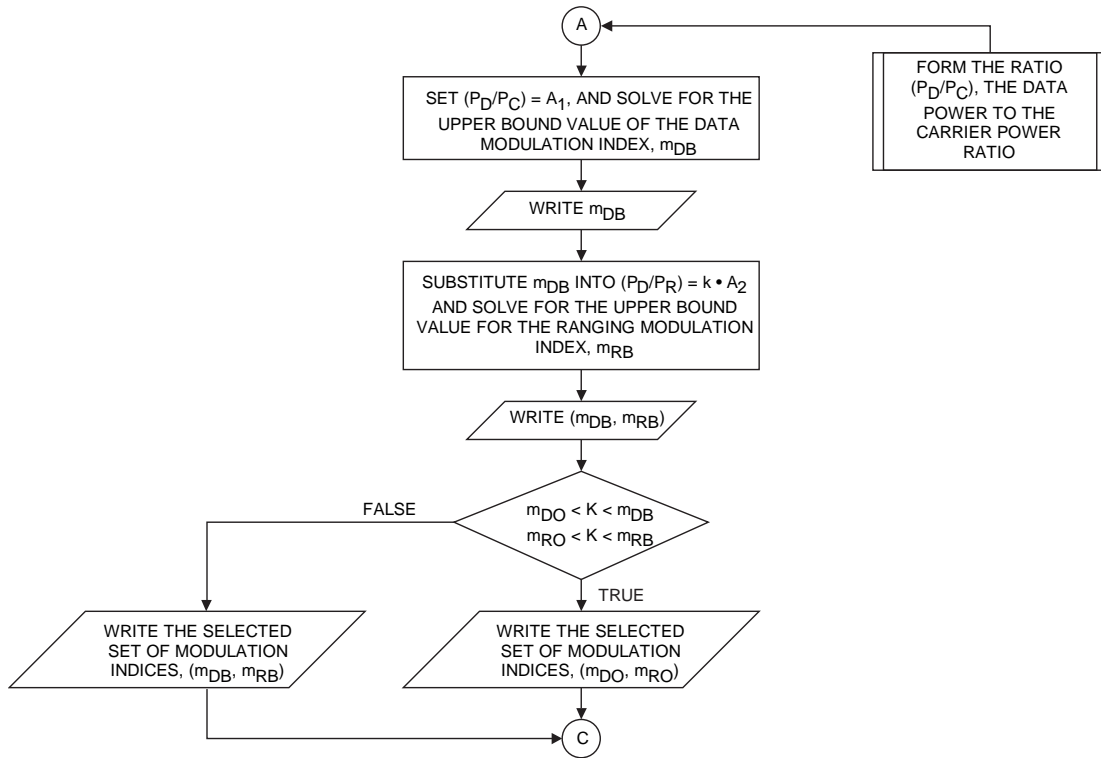

LEGEND:

- (E_b/N_0) (dB) = REQUIRED BIT SNR TO ACHIEVE A DESIRED BER IN dB
- $2 B_{LO}$ (dB-Hz) = TWO-SIDED P_{LL} NOISE BANDWIDTH IN dB-Hz
- $(SNR)_{2 B_{LO}}$ (dB) = REQUIRED OPERATING THRESHOLD IN dB
- BR (dB-Hz) = REQUIRED DATA BIT RATE IN dB-Hz
- $(SNR)_{\Delta D}$ (dB) = SNR DEGRADATION DUE TO RECEIVER HARDWARE IN dB
- BW_R (dB-Hz) = RANGING BANDWIDTH IN dB-Hz (2-SIDED)
- $(SNR)_{BW}$ (dB) = REQUIRED RANGING SNR BW_R , EXPRESSED IN dB
- $(SNR)_{\Delta R}$ (dB) = SNR DEGRADATION DUE TO RANGING RECEIVER HARDWARE IN dB
- ΔS = RANGING SUPPRESSION RELATIVE TO DATA POWER LEVEL IN dB
- K = DESIGN FACTOR
- Δ_D (dB) = DEGRADATION IN THE DATA CHANNEL DUE TO THE INTERFERENCE FROM THE RANGING CHANNEL
- m_D = DATA CHANNEL MODULATION INDEX IN RADIAN
- m_R = RANGING CHANNEL MODULATION INDEX IN RADIAN
- P_D = THE RECOVERABLE POWER IN THE FIRST-ORDER SIDEBAND OF THE DATA CHANNEL
- P_R = THE RECOVERABLE POWER IN THE FIRST-ORDER SIDEBAND OF THE RANGING CHANNEL
- P_T = TOTAL TRANSMITTED POWER
- P_C = THE RECOVERABLE POWER IN THE CARRIER CHANNEL
- CM_C = CALCULATED CARRIER PERFORMANCE MARGIN
- DM_C = CALCULATED DATA PERFORMANCE MARGIN
- RM_C = CALCULATED RANGING MARGIN
- CM_{REQ} = REQUIRED CARRIER PERFORMANCE MARGIN
- DM_{REQ} = REQUIRED DATA PERFORMANCE MARGIN
- RM_{REQ} = REQUIRED RANGING PERFORMANCE MARGIN

Figure 4.1.1-1: MT's Algorithm: An Algorithm to Search for a Set of Optimum Modulation Indices for Simultaneous Command / Telemetry / Range Operations

Earth Stations and Spacecraft

4.1.1 SELECTION OF OPTIMUM MODULATION INDICES FOR SIMULTANEOUS RANGING, TELECOMMAND, AND TELEMETRY OPERATIONS (Continued)

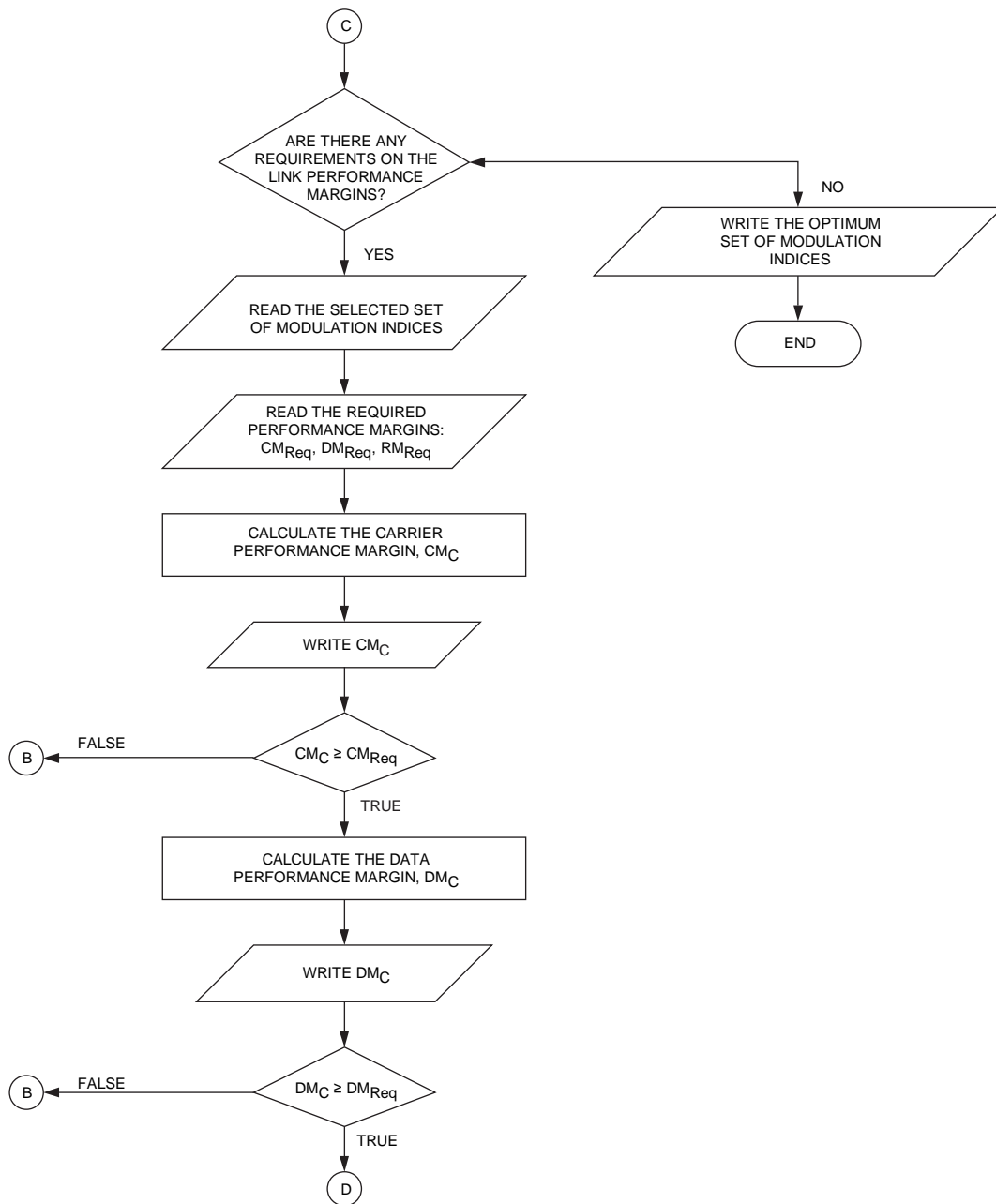
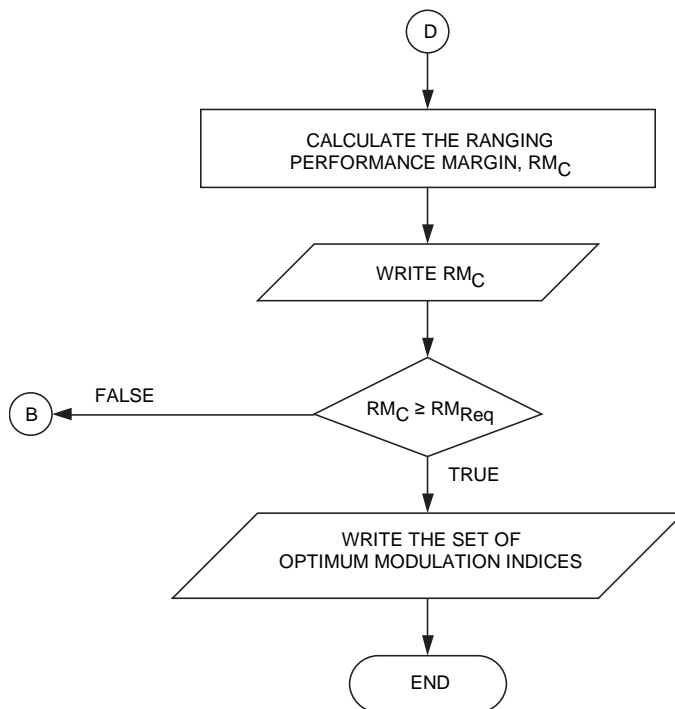

Figure 4.1.1-1: MT's Algorithm: An Algorithm to Search for a Set of Optimum Modulation Indices for Simultaneous Command / Telemetry / Range Operations

Earth Stations and Spacecraft

4.1.1 SELECTION OF OPTIMUM MODULATION INDICES FOR SIMULTANEOUS RANGING, TELECOMMAND, AND TELEMETRY OPERATIONS (Continued)



6485-23012Dn

Figure 4.1.1-1: MT's Algorithm: An Algorithm to Search for a Set of Optimum Modulation Indices for Simultaneous Command / Telemetry / Range Operations

Earth Stations and Spacecraft

**4.1.2 TELECOMMUNICATIONS LINK DESIGN CONTROL TABLE
(Link and Weather Not Combined)**

The CCSDS,

considering

- (a) that an ability to exchange telecommunications link performance information is necessary for agencies to engage in cooperative space missions, conduct joint space ventures, and provide ground station cross support to another agency's spacecraft;
- (b) that a uniform method for presenting link parameters and calculating link performance will facilitate the exchange of information;
- (c) that a uniform Design Control Table (DCT) is a convenient method for displaying telecommunications link performance information;
- (d) that the order in which the parameters are arranged in the Design Control Table can affect its clarity and the ease with which a signal can be traced through a telecommunications system;
- (e) that nominal link parameter values, representing the expected performance by the link, are important to an understanding of the telecommunications system;
- (f) that favorable and adverse tolerances on the nominal link parameter values are required to provide confidence in the link's performance;

recommends

- (1) that the uniform Design Control Table, consisting of the general information and link performance pages contained in the Annex, be used as a means for comparing telecommunications link performance calculations between agencies;
- (2) that in computing favorable and adverse tolerances on the nominal performance values, agencies should use 3-sigma values for the telecommand system and use 2-sigma values for all other systems.

Earth Stations and Spacecraft

[This page is intentionally blank.]

Earth Stations and Spacecraft

4.1.2 ANNEX - TELECOMMUNICATIONS LINK DESIGN CONTROL TABLE

**CCSDS LINK DESIGN CONTROL TABLE
 GENERAL INFORMATION
 (Link and Weather Not Combined)**

Page 1

1	Owner CCSDS Agency	
2	Name of Mission	
3	Name of Spacecraft	
4	Mission Category a. A = Alt.<2,000,000 km b. B = Alt.>2,000,000 km	
5	Link Budget Number	
6	Revision No. / Conditions	
7	Date	
8	File Name	
9	Project Name: Cognizant Person Title: Address: Telephone No: Fax No: E-Mail No:	
10	Network Name: Cognizant Person Address: Telephone No: FAX No: E-Mail No:	

Earth Stations and Spacecraft

4.1.2 ANNEX (Cont.) - TELECOMMUNICATIONS LINK DESIGN CONTROL TABLE

CCSDS LINK DESIGN CONTROL TABLE
COMMUNICATIONS SYSTEM OPERATING CONDITIONS
(Link and Weather Not Combined)

Page 2

EARTH - SPACE - LINK			SPACE - EARTH - LINK		
E/S TRANSMITTING RF CHANNEL:			S/C TRANSMITTING RF CHANNEL:		
1	RF Carrier Modulation		11	RF Carrier Modulation	
	a. Ch 1 Type			a. Ch 1 Type	
	b. Ch 1 Format			b. Ch 1 Format	
	c. Ch 2 Type			c. Ch 2 Type	
	d. Ch 2 Format			d. Ch 2 Format	
E/S TRANSMITTING DATA CHANNEL:			S/C TRANSMITTING DATA CHANNEL:		
2	Baseband Data		12	Baseband Data	
	a. Ch 1 Bit Rate, b/s			a. Ch 1 Bit Rate, kb/s	
	b. Ch 1 Bit Error Rate			b. Ch 1 Bit Error Rate	
	c. Ch 2 Bit Rate, b/s			c. Ch 2 Bit Rate, kb/s	
	d. Ch 2 Bit Error Rate			d. Ch 2 Bit Error Rate	
3	Data Coding		13	Data Coding	
	a. Ch 1 Type			a. Ch 1 Rate	
	b. Ch 1 No. Info Bits			b. Ch 1 Constraint Length	
	c. Ch 1 Block Length			c. Ch 1 Concatenated Code	
				d. Ch 1 Data/Total Bits	
	d. Ch 2 Type			e. Ch 2 Rate	
	e. Ch 2 No. Info Bits			f. Ch 2 Constraint Length	
f. Ch 2 Block Length		g. Ch 2 Concatenated Code			
		h. Ch 2 Data/Total Bits			
4	Subcarrier		14	Subcarrier	
	a. Ch 1 Waveform			a. Ch 1 Waveform	
	b. Ch 1 Frequency			b. Ch 1 Frequency	
	c. Ch 1 Mod Type			c. Ch 1 Modulation Type	
	d. Ch 2 Waveform			d. Ch 2 Waveform	
	e. Ch 2 Frequency			e. Ch 2 Frequency	
	f. Ch 2 Mod Type			f. Ch 2 Modulation Type	
E/S TRANSMITTING RNG CHANNEL:			S/C - E/S RNG CHANNEL:		
5	a. System Type		15	a. Code Regeneration	
	b. Tone/Code Wavfrm			b. Coherent Ops Req'd	
	c. Highest Frequency			c. Required Accuracy (m)	
	d. Lowest Frequency			d. Bandwidth T/C 1 (Hz)	
	e. Total Comp No.			e. Bandwidth T/C 2 (Hz)	
EARTH-TO-SPACE PATH PERFORMANCE:			SPACE-TO-EARTH PATH PERFORMANCE:		
6	a. Weather Avail (%)		16	a. Weather Avail (%)	
	b. S/C Distance (km)			b. S/C Distance (km)	

CCSDS HISTORICAL DOCUMENT
 CCSDS RECOMMENDATIONS FOR RADIO FREQUENCY AND MODULATION SYSTEMS

Earth Stations and Spacecraft

4.1.2 ANNEX (Cont.) - TELECOMMUNICATIONS LINK DESIGN CONTROL TABLE

CCSDS LINK DESIGN CONTROL TABLE
EARTH - SPACE - LINK
INPUT DATA SHEET
 (Link and Weather Not Combined)

Page 3

MISSION AND SPACECRAFT		UNITS	CHANNEL 1			CHANNEL 2		
			DESIGN VALUE	FAV TOL	ADV TOL	DESIGN VALUE	FAV TOL	ADV TOL
E/S TRANSMITTING RF CARRIER CHANNEL PARAMETERS:								
1	Transmitter Power	dBW						
2	Transmitter Frequency	MHz						
3	Antenna Gain	dBi						
4	Antenna Circuit Loss	dB						
5	Antenna Pointing Loss	dB						
E/S TRANSMITTING DATA CHANNEL PARAMETERS:								
6	Information Bit Rate	b/s						
7	Subcarrier Frequency	kHz						
8	Subcarrier Waveform	Sin-Sq						
9	RF Modulation Index	Rad-pk						
E/S TRANSMITTING RANGING CHANNEL PARAMETERS:								
10	Simultaneous With Data	Yes-No						
11	Ranging Waveform	Sin-Sq						
12	a. Mod Index Tone/Code 1	Rad-pk						
	b. Mod Index Tone/Code 2	Rad-pk						
EARTH - TO - SPACE PATH PARAMETERS:								
13	Topocentric Range	km						
14	Atmospheric Attenuation	dB						
15	Ionospheric Loss	dB						
16	Antenna Elevation Angle	deg						
S/C RECEIVING RF CARRIER CHANNEL PARAMETERS:								
17	Antenna Gain	dBi						
18	Polarization Loss	dB						
19	Antenna Pointing Loss	dB						
20	Antenna Circuit Loss	dB						
21	Carrier Circuit Loss	dB						
22	Total Noise Temperature	K						
	a. Receiver Operating Temp	K						
	b. Feed Through Noise	K						
	c. Hot Body Noise	K						
23	Threshold Loop Noise BW	Hz						
24	Reqd Threshold SNR in 2 B _L O	dB						
S/C RECEIVING DATA CHANNEL PARAMETERS:								
25	Phase Jitter Loss	dB						
26	Demodulator / Detector Loss	dB						
27	Waveform Distortion Loss	dB						
28	Max Rng Interference to Data	dB						
29	Reqd Data E _b /N ₀	dB						
S/C RECEIVING RNG CHANNEL PARAMETERS:								
30	Ranging Demodulator Loss	dB						
31	Ranging Filter Bandwidth	MHz						
32	Required Tone/Code 1 SNR	dB						
33	Required Tone/Code 2 SNR	dB						

Earth Stations and Spacecraft

4.1.2 ANNEX (Cont.) - TELECOMMUNICATIONS LINK DESIGN CONTROL TABLE

CCSDS LINK DESIGN CONTROL TABLE
SPACE - EARTH - LINK
INPUT DATA SHEET
 (Link and Weather Not Combined)

MISSION AND SPACECRAFT		UNITS	CHANNEL 1			CHANNEL 2		
			DESIGN VALUE	FAV TOL	ADV TOL	DESIGN VALUE	FAV TOL	ADV TOL
S/C TRANSMITTING RF CARRIER CHANNEL PARAMETERS:								
51	Transmitter Power	dBW						
52	Transmitter Frequency	MHz						
53	Antenna Gain	dBi						
54	Antenna Circuit Loss	dB						
55	Antenna Pointing Loss	dB						
S/C TRANSMITTING DATA CHANNEL PARAMETERS:								
56	Information Bit Rate	kb/s						
57	Subcarrier Frequency	kHz						
58	Subcarrier Waveform	Sin-Sq						
59	RF Modulation Index	Rad-pk						
S/C TRANSMITTING RNG CHANNEL PARAMETERS:								
60	Simultaneous With Data	Yes-No						
61	Mod Index Tone/Code	Rad-pk						
SPACE - TO - EARTH PATH PARAMETERS:								
62	Topocentric Range	km						
63	Atmospheric Attenuation	dB						
64	Ionospheric Loss	dB						
65	Antenna Elevation Angle	deg						
E/S RECEIVING RF CARRIER CHANNEL PARAMETERS:								
66	Ant Gain	dBi						
67	Polarization Loss	dB						
68	Antenna Pointing Loss	dB						
69	Antenna Circuit Loss	dB						
70	Total Noise Temperature	K						
	a. Receiver Operating Temp	K						
	b. Feed Through Noise	K						
	c. Hot Body Noise	K						
	d. Weather Temp Increase	K						
71	Threshold Loop Noise BW	Hz						
72	Reqd Threshold SNR in 2 B _{LO}	dB						
E/S RECEIVING DATA CHANNEL PARAMETERS:								
73	Phase Jitter Loss	dB						
74	Demodulator / Detector Loss	dB						
75	Waveform Distortion Loss	dB						
76	Max Rng Interference to Data	dB						
77	Required Data E _p /N ₀	dB						
E/S RECEIVING RNG CHANNEL PARAMETERS:								
78	Ranging Demodulator Loss	dB						
79	Required Tone/Code 1 Pwr/No	dB-Hz						
80	Required Tone/Code 2 Pwr/No	dB-Hz						

CCSDS HISTORICAL DOCUMENT
CCSDS RECOMMENDATIONS FOR RADIO FREQUENCY AND MODULATION SYSTEMS

Earth Stations and Spacecraft

4.1.2 ANNEX (Cont.) - TELECOMMUNICATIONS LINK DESIGN CONTROL TABLE

CCSDS LINK DESIGN CONTROL TABLE
EARTH - TO - SPACE LINK
LINK COMPUTATIONS
(Link and Weather Not Combined)

Page 5

MISSION AND SPACECRAFT		UNITS	DESIGN VALUE	MEAN VALUE	VARIANCE	PDF REF	REMARKS
E/S TRANSMITTING RF CARRIER CHANNEL PERFORMANCE:							
101	Transmitter Power	dBW				TRI	
102	Transmit Antenna Gain [Effect]	dB				UNI	
103	Transmit EIRP	dBW				TRI	
104	Transmit Carrier Power	dBW				TRI	
105	Transmit Carrier Power/ P_T	dB				TRI	
E/S TRANSMITTING DATA CHANNEL PERFORMANCE:							
106	Transmit Ch 1 Data Power	dBW				TRI	
107	Transmit Ch 1 Data Power/ P_T	dB				TRI	
108	Transmit Ch 2 Data Power	dBW				TRI	
109	Transmit Ch 2 Data Power/ P_T	dB				TRI	
E/S TRANSMITTING RNG CHANNEL PERFORMANCE:							
110	Tone - Code 1 Power	dBW				TRI	
111	Tone - Code 1 Power/ P_T	dB				TRI	
112	Tone - Code 2 Power	dBW				TRI	
113	Tone - Code 2 Power/ P_T	dB				TRI	
EARTH - TO - SPACE PATH PERFORMANCE:							
114	Free Space Loss	dB				TRI	
115	Atmospheric Attenuation	dB				GAU	
116	Ionospheric Loss	dB				GAU	
S/C RECEIVING RF CARRIER CHANNEL PERFORMANCE:							
117	Receiving Antenna Gain [Effect]	dBi				UNI	
118	Noise Spectral Density	dBW/Hz				GAU	
119	Threshold Loop BW, $2 B_{LO}$	Hz				TRI	
120	Received Carrier Power	dBW				TRI	
121	Carrier Performance Margin	dB				TRI	
S/C RECEIVING DATA CHANNEL PERFORMANCE:							
122	Ch 1 Data Loss Due to Rng	dB				TRI	
123	Received Ch 1 E_b/N_o	dB				TRI	
124	Required Ch 1 E_b/N_o	dB					
125	Ch 1 Data Performance Margin	dB				TRI	
126	Ch 2 Data Loss Due to Rng	dB				TRI	
127	Received Ch 2 E_b/N_o	dB				TRI	
128	Required Ch 2 E_b/N_o	dB					
129	Ch 2 Data Performance Margin	dB				TRI	
S/C RECEIVING RNG CHANNEL PERFORMANCE:							
130	Received Code 1 Power / No	dB-Hz				TRI	
131	Received Code 2 Power / No	dB-Hz				TRI	
132	Received Total Rng Power / No	dB-Hz				TRI	
133	Ranging Margin	dB				TRI	

Earth Stations and Spacecraft

4.1.2 ANNEX (Cont.) - TELECOMMUNICATIONS LINK DESIGN CONTROL TABLE

CCSDS LINK DESIGN CONTROL TABLE
SPACE - TO - EARTH LINK
LINK COMPUTATIONS
 (Link and Weather Not Combined)

MISSION AND SPACECRAFT		UNITS	DESIGN VALUE	MEAN VALUE	VARIANCE	PDF REF	REMARKS
S/C TRANSMITTING RF CARRIER CHANNEL PERFORMANCE:							
151	Transmitter Power	dBW				TRI	
152	Transmit Antenna Gain [Effect]	dB				UNI	
153	Transmit EIRP	dBW				TRI	
154	Transmit Carrier Power	dBW				TRI	
155	Transmit Carrier Power/ P_T	dB				TRI	
S/C TRANSMITTING DATA CHANNEL PERFORMANCE:							
156	Transmit Ch 1 Data Power	dBW				TRI	
157	Transmit Ch 1 Data Power/ P_T	dB				TRI	
158	Transmit Ch 2 Data Power	dBW				TRI	
159	Transmit Ch 2 Data Power/ P_T	dB				TRI	
S/C TRANSMITTING RNG CHANNEL PERFORMANCE:							
160	Tone - Code 1 Power	dBW				TRI	
161	Tone - Code 1 Power/ P_T	dB				TRI	
162	Tone - Code 2 Power	dBW				TRI	
163	Tone - Code 2 Power/ P_T	dB				TRI	
SPACE - TO - EARTH PATH PERFORMANCE:							
164	Free Space Loss	dB				TRI	
165	Atmospheric Attenuation	dB				GAU	
166	Ionospheric Loss	dB				GAU	
E/S RECEIVING RF CARRIER CHANNEL PERFORMANCE:							
167	Receiving Antenna Gain [Effect]	dB				UNI	
168	Noise Spectral Density	dBW/Hz				GAU	
169	Threshold Loop BW, $2 B_{LO}$	Hz				TRI	
170	Received Carrier Power	dBW				TRI	
171	Carrier Performance Margin	dB				GAU	
E/S STATION RECEIVING DATA CHANNEL PERFORMANCE:							
172	Ch 1 Data Loss Due to Rng	dB				TRI	
173	Received Ch 1 E_b/N_o	dB				TRI	
174	Required Ch 1 E_b/N_o	dB					
175	Ch 1 Data Performance Margin	dB				GAU	
176	Ch 2 Data Loss Due to Rng	dB				TRI	
177	Received Ch 2 E_b/N_o	dB				TRI	
178	Required Ch 2 E_b/N_o	dB					
179	Ch 2 Data Performance Margin	dB				GAU	
E/S STATION RECEIVING RNG CHANNEL PERFORMANCE:							
180	Received Code 1 Power / No	dB-Hz				TRI	
181	Received Code 2 Power / No	dB-Hz				TRI	
182	Received Total Rng Power / No	dB-Hz				TRI	
183	Ranging Performance Margin	dB				GAU	

Earth Stations and Spacecraft

4.1.2 ANNEX (Cont.) - TELECOMMUNICATIONS LINK DESIGN CONTROL TABLE

CCSDS LINK DESIGN CONTROL TABLE
EXPLANATION OF REMARKS
(Link and Weather Not Combined)

UPLINK	
1	Design value of the Transmitted Carrier Power (dBW) is computed using the design value of P_c/P_t and the EIRP. The design value of P_c/P_t is computed by using the design values of the several modulation indices.
2	Mean Transmitted Carrier Power (dBW) is computed by examining all combinations of favorable and adverse tolerances for the several modulation indices, selecting the best and worst cases, and computing P_c/P_t and EIRP. The variance on Transmitted Carrier Power (dBW) is computed by using the EIRP with the favorable and adverse tolerances of P_c/P_t .
2A	A triangular probability density is used for P_c/P_t ratio.
3	Design value of the Transmitted Data Power (dBW) is computed using design value of P_d/P_t and of the EIRP. The design value of P_d/P_t is computed by using the design values of the several modulation indices.
4	Mean Transmitted Data Power (dBW) is computed by examining all combinations of favorable and adverse tolerances for the several modulation indices, selecting the best and worst cases, and computing P_d/P_t and EIRP. The variance on Transmitted Data Power (dBW) is computed by using the EIRP with the favorable and adverse tolerances of P_d/P_t .
4A	A triangular probability density is used for the P_d/P_t ratio.
5	Design value of the Transmitted Ranging Power (dBW) is computed using the design value of P_r/P_t and of the EIRP. The design value of P_r/P_t is computed by using the design values of the several modulation indices.
6	Mean Transmitted Ranging Power (dBW) is computed by examining all combinations of favorable and adverse tolerances for the several modulation indices, selecting the best and worst cases, and computing P_r/P_t and EIRP. The variance of Transmitted Ranging Power (dBW) is computed by using the EIRP with the favorable and adverse tolerances of P_r/P_t .
6A	A triangular probability density is used for the P_r/P_t ratio.
7, 8	Space Loss: Mean and variance on the space loss are computed using the favorable and adverse tolerances of the Earth station - spacecraft range.
9	Atmospherics losses are assumed to be statistically independent of the link when computing margins. Mean and variance are computed using the appropriate weather model.
DOWNLINK	
10	Same as remark 1 but applied for the downlink.
11	Same as remark 2 but applied for the downlink.
11A	Same as remark 2a but applied for the downlink.
12	Same as remark 3 but applied for the downlink.
13	Same as remark 4 but applied for the downlink.
13A	Same as remark 4a but applied for the downlink.
14	Same as remark 5 but applied for the downlink.
15	Same as remark 6 but applied for the downlink.
15A	Same as remark 6a but applied for the downlink.
16	Same as remark 7 but applied for the downlink.
17	Same as remark 8 but applied for the downlink.
18	Same as remark 9 but applied for the downlink.

Earth Stations and Spacecraft

4.1.2 ANNEX (Cont.) - TELECOMMUNICATIONS LINK DESIGN CONTROL TABLE

**CCSDS LINK DESIGN CONTROL TABLE
 EXPLANATION OF REMARKS (Cont.)
 (Link and Weather Not Combined)**

NOTES:..... UPLINK
1. Required Tone/Code 1 SNR means the required tone / code 1 ranging power divided by the noise power in the ranging bandwidth. The user is expected to enter the value in sheet 3, line 32.
2. When the ranging margin is computed, the ranging bandwidth is used to obtain the required power-to-noise density ratio. Thereafter, this required ranging power-to-noise density ratio is subtracted from the received ranging power-to-noise density ratio to obtain the ranging margin.
DOWNLINK
1. Required ranging Tone/Code Pwr/ N_0 ratio is computed automatically for DSN square wave and GSFC sidetone sinewave ranging systems. For other systems, the Required Tone/Code Pwr/ N_0 ratio must be provided by the user. The following steps should be followed. <ul style="list-style-type: none"> a. Specify Tone/Code integration time needed meet accuracy requirements. b. Compute effective bandwidth (e.g., $1/\text{Integration Time}$). c. Using appropriate data for the ranging system in use, find required P_r/N_0 needed to meet the specified accuracy, given the desired integration time, and enter this value on line 79.
2. Ranging margin is based on effective bandwidth computed in 1b above.

Earth Stations and Spacecraft

**4.1.3 STANDARD TERMINOLOGY FOR TELECOMMUNICATIONS LINK
PERFORMANCE CALCULATIONS**

The CCSDS,

considering

- (a) that a uniform method for computing telecommunications link performance is desirable in order to facilitate the exchange of information among agencies;
- (b) that it is necessary to agree upon the definitions of certain key terms before a uniform method for computing telecommunications link performance can be adopted;
- (c) that definitions which have been adopted by internationally recognized organizations for such key terms should be used whenever possible;

recommends

- (1) that the terms listed in Article 1 of the Radio Regulations and in the Annex below be used together with the meaning ascribed to them in the corresponding definition;
- (2) that the telecommunications link, together with the noise sources and losses, be described as shown in figure 4.1.3-1.

ANNEX TO RECOMMENDATION 4.1.3

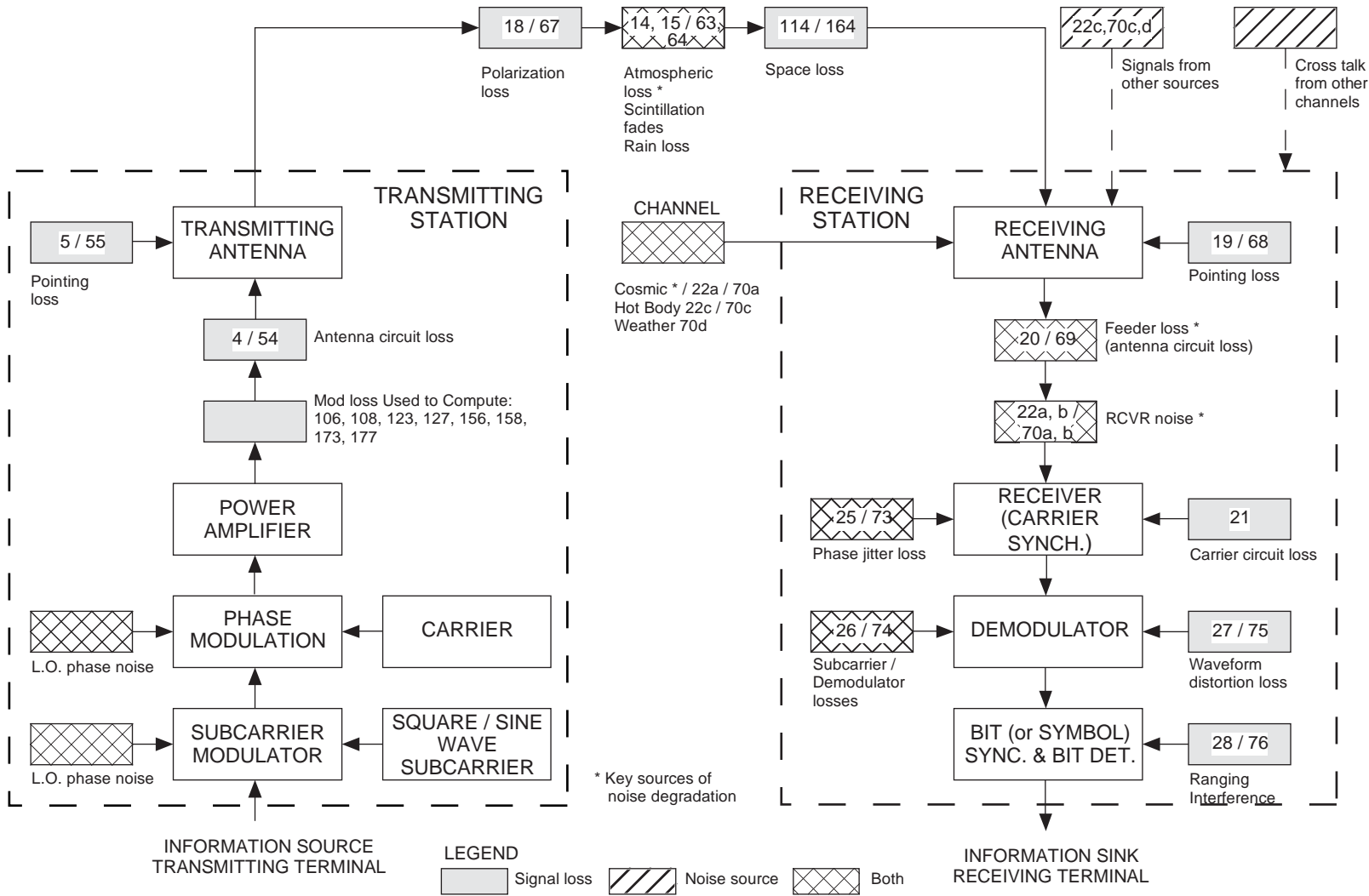

Figure 4.1.3-1: Typical Space Communications Link Showing Loss and Noise Sources

Earth Stations and Spacecraft

4.1.3 ANNEX TO RECOMMENDATION

TELECOMMUNICATIONS LINK DESIGN CONTROL TABLE (Link and Weather Not Combined): A set of informational and input data tables for the user to provide the salient Earth-to-space and space-to-Earth telecommunications equipment and link characteristics together with tables containing the computed performance of these links without regard to weather induced effects.

GENERAL INFORMATION

- (1) *OWNER CCSDS AGENCY:* The CCSDS member agency having primary responsibility for the success or failure of the mission.
- (2) *NAME OF MISSION:* The name given to the mission by the CCSDS member agency owner.
- (3) *NAME OF SPACECRAFT:* The name given to a specific spacecraft, which is part of the named mission, by the CCSDS member agency owner.
- (4) *MISSION CATEGORY:* The mission's category, either Category B for deep space missions (missions whose altitude above the Earth's surface exceeds 2×10^6 km) or Category A for non-deep space missions (those whose altitude above the Earth's surface are less than, or equal to, 2×10^6 km).
- (5) *LINK BUDGET NUMBER:* A number which is assigned to this link budget study under the conditions and with the configuration stated on the following pages to distinguish it from other such studies.
- (6) *REVISION No. / CONDITIONS:* The most recent revision of this telecommunications link budget study, which is contained in this table, for the named spacecraft and mission together with a short description of the study conditions (e.g., transmitter power, station used, etc.).
- (7) *DATE:* The date that this study or revision was made.
- (8) *FILE NAME:* The name or number of the file, whether on a computer disk or other media, where this DCT is stored.
- (9) *PROJECT COGNIZANT PERSON:*

Name: The name of the cognizant person in the owner agency with whom inputs to, or outputs from, this Design Control Table should be discussed and approved.

Title: The cognizant person's position or title.

Address: The full agency center's name and address which is required to contact the cognizant person in an efficient manner.

Telephone No: The cognizant person's telephone number, including country and area code.

FAX No: The cognizant person's FAX number, including country and area code.

E-Mail No.: The cognizant person's full e-mail address, including any relevant node.

Earth Stations and Spacecraft

4.1.3 ANNEX TO RECOMMENDATION (Continued)

GENERAL INFORMATION (Continued)

(10) NETWORK COGNIZANT PERSON:

Name: The name of the cognizant person in the agency operating the supporting network with whom inputs to, or outputs from, this Design Control Table should be discussed and approved.

Address: The full network agency center's name and address which is required to contact the cognizant person in an efficient manner.

Telephone No: The cognizant person's telephone number, including country and area code.

FAX No: The cognizant person's FAX number, including country and area code.

E-Mail No: The cognizant person's full e-mail address, including any relevant node.

Earth Stations and Spacecraft

4.1.3 ANNEX TO RECOMMENDATION (Continued)

COMMUNICATIONS SYSTEM OPERATING CONDITIONS

EARTH-TO-SPACE LINK

EARTH STATION (E/S) TRANSMITTING RF CHANNEL

- (1) *RF CARRIER MODULATION:*
 - (1a) *Ch 1 Type:* The Earth station's carrier modulation method. Generally, only phase modulation is recommended by the CCSDS for the RF carrier.
 - (1b) *Ch 1 Format:* The method used in the Earth station to represent the modulated Telecommand symbols on the carrier (e.g., NRZ-L, NRZ-M, SP-L, etc.).
 - (1c) *CH 2 Type:* Same definition as (1a) above except that it is applicable to RF channel 2.
 - (1d) *Ch 2 Format:* Same definition as (1b) above except that it is applicable to RF channel 2.

EARTH STATION (E/S) TRANSMITTING DATA CHANNEL

- (2) *BASEBAND DATA:*
 - (2a) *Ch 1 Bit Rate, b/s:* The rate, usually the maximum, at which uncoded telecommand or other data on channel 1 is to be transmitted from the Earth station and for which the link performance is to be evaluated, expressed in b/s.
 - (2b) *Ch 1 Bit Error Rate:* The maximum information bit error rate providing acceptable performance for data channel 1 under consideration, expressed as a dimensionless fraction.
 - (2c) *Ch 2 Bit Rate, b/s:* Same definition as (2a) above except that it is applicable to channel 2.
 - (2d) *Ch 2 Bit Error Rate:* Same definition as (2b) above except that it is applicable to channel 2.
- (3) *DATA CODING:*
 - (3a) *Ch 1 Type:* The type or name (e.g., block, Reed-Solomon, etc.) of the error detecting-correcting code used on data channel 1 by the Earth station.
 - (3b) *Ch 1 No. Info Bits:* The number of information bits contained in a block code on data channel 1 which is transmitted from the Earth station, expressed as a number.
 - (3c) *Ch 1 Block Length:* The total length of the block used on data channel 1 from the Earth station, expressed as a number.
 - (3d) *Ch 2 Type:* Same definition as (3a) above except that it is applicable to data channel 2.

Earth Stations and Spacecraft

4.1.3 ANNEX TO RECOMMENDATION (Continued)

- (3e) *Ch 2 No. Info Bits*: Same definition as (3b) above except that it is applicable to channel 2.
- (3f) *Ch 2 Block Length*: Same definition as (3c) above except that it is applicable to channel 2.
- (4) *SUBCARRIER*:
- (4a) *Ch 1 Waveform*: The Earth station's subcarrier waveform on data channel 1. Sine wave subcarriers are recommended by the CCSDS for telecommand.
- (4b) *Ch 1 Frequency*: The Earth station's subcarrier frequency on data channel 1, expressed in kHz.
- (4c) *Ch 1 Mod Type*: The method used by the Earth station for modulating the subcarrier with the data. PSK modulation is recommended by the CCSDS for telecommand subcarriers.
- (4d) *Ch 2 Waveform*: Same definition as (4a) except that it is applicable to channel 2.
- (4e) *Ch 2 Frequency*: Same definition as (4b) above except that it is applicable to channel 2.
- (4f) *Ch 2 Mod Type*: Same definition as (4c) above except that it is applicable to channel 2.

EARTH STATION (E/S) TRANSMITTING RNG CHANNEL

- (5a) *System Type*: The name, or descriptive term used to identify the specific ranging equipment (e.g., sidetone, square wave, DLR sine wave, CNES sine wave, ESA sine wave, DSN square wave, etc.).
- (5b) *Tone/Code Waveform*: The ranging tone or code waveform (e.g., sine or square).
- (5c) *Highest Frequency*: The highest ranging tone or code frequency to be used for this mission, expressed in kHz.
- (5d) *Lowest Frequency*: The lowest ranging tone or code frequency to be used for this mission, expressed in kHz.
- (5e) *Total Comp No*: The total number of ranging tone or code components which will be used in measuring the range, expressed as a number.

EARTH-TO-SPACE PATH PERFORMANCE

- (6a) *Weather Avail (%)*: The amount of time that the Earth-to-space link must be available when considering the degradation due to weather, expressed as a percent.
- (6b) *S/C Distance (km)*: The distance, measured along a ray path, between the Earth station transmitting antenna's radiation point and the spacecraft receiving antenna's reference point, expressed in kilometers (km).

Earth Stations and Spacecraft

4.1.3 ANNEX TO RECOMMENDATION (Continued)

COMMUNICATIONS SYSTEM OPERATING CONDITIONS (Cont.)

SPACE-TO-EARTH LINK

SPACECRAFT (S/C) TRANSMITTING RF CHANNEL

- (11) *RF CARRIER MODULATION:*
- (11a) *Ch 1 Type:* The spacecraft's carrier modulation method. Generally, only phase modulation is recommended by the CCSDS for the RF carrier.
- (11b) *Ch 1 Format:* The method used by the spacecraft to represent the modulated Telemetry symbols on the carrier (e.g., NRZ-L, NRZ-M, SP-L, etc.).
- (11c) *CH 2 Type:* Same definition as (11a) above except that it is applicable to RF channel 2.
- (11d) *Ch 2 Format:* Same definition as (11b) above except that it is applicable to RF channel 2.

SPACECRAFT (S/C) TRANSMITTING DATA CHANNEL

- (12) *BASEBAND DATA:*
- (12a) *Ch 1 Bit Rate, kb/s:* The rate, usually the maximum, at which uncoded telemetry or other data on channel 1 is to be transmitted from the spacecraft and for which the link performance is to be evaluated, expressed in kilo b/s.
- (12b) *Ch 1 Bit Error Rate:* The maximum information bit error rate providing acceptable performance for data channel 1 under consideration, expressed as a dimensionless fraction.
- (12c) *Ch 2 Bit Rate, kb/s:* Same definition as (12a) above except that it is applicable to channel 2.
- (12d) *Ch 2 Bit Error Rate:* Same definition as (12b) above except that it is applicable to channel 2.
- (13) *DATA CODING:*
- (13a) *Ch 1 Rate:* The ratio of the number of data bits to the total number of convolutionally encoded symbols transmitted from the spacecraft, generally expressed as a fraction (e.g., $1/2$ for the CCSDS recommended code).
- (13b) *Ch 1 Constraint Length:* The constraint length of the convolutional encoder on the spacecraft, expressed as a number (e.g., 7 for the CCSDS recommended code).
- (13c) *Ch 1 Concatenated Code:* The type or name of the code which is concatenated with the convolutional code on the spacecraft (e.g., Reed-Solomon, Golay, block, etc.). The CCSDS recommends Reed-Solomon.

Earth Stations and Spacecraft

4.1.3 ANNEX TO RECOMMENDATION (Continued)

- (13d) *Ch 1 Data/Total Bits*: The number of data bits to total bits in a spacecraft block code, expressed as a ratio (e.g., 223/255 for the CCSDS recommended Reed-Solomon code).
- (13e) *Ch 2 Rate*: Same definition as (13a) above except that it is applicable to channel 2.
- (13f) *Ch 2 Constraint Length*: Same definition as (13b) above except that it is applicable to channel 2.
- (13g) *Ch 2 Concatenated Code*: Same definition as (13c) above except that it is applicable to channel 2.
- (13h) *Ch 2 Data/Total Bits*: Same definition as (13d) above except that it is applicable to channel 2.
- (14) **SUBCARRIER**:
- (14a) *Ch 1 Waveform*: The spacecraft's subcarrier waveform on data channel 1 (e.g., sine or square).
- (14b) *Ch 1 Frequency*: The spacecraft's subcarrier frequency on data channel 1, expressed in kHz.
- (14c) *Ch 1 Modulation Type*: The spacecraft's method used for modulating the subcarrier with the data. PSK modulation is recommended by the CCSDS for telemetry subcarriers.
- (14d) *Ch 2 Waveform*: Same definition as (14a) above except that it is applicable to channel 2.
- (14e) *Ch 2 Frequency*: Same definition as (14b) above except that it is applicable to channel 2.
- (14f) *Ch 2 Modulation Type*: Same definition as (14c) above except that it is applicable to data channel 2.

SPACECRAFT (S/C) - EARTH STATION (E/S) RNG CHANNEL

- (15a) *Code Regeneration*: A statement (Yes or No) indicating whether the spacecraft regenerates the ranging code prior to transmitting it to the Earth station.
- (15b) *Coherent Ops Req'd*: A statement (Yes or No) indicating whether the Earth station's ranging equipment requires a coherent spacecraft RF channel.
- (15c) *Required Accuracy (m)*: The required ranging measurement accuracy, expressed in meters.
- (15d) *Bandwidth T/C 1 (Hz)*: The Earth station's effective bandwidth (1/integration time) required to obtain the ranging measurement accuracy stated in 5c, above, with the P_T / N_O stated on the Input Data Sheet, expressed in Hz.
- (15e) *Bandwidth T/C 2 (Hz)*: The Earth station's effective bandwidth (1/integration time) required to obtain the required probability of success in the ranging measurement, expressed in Hz.

Earth Stations and Spacecraft

4.1.3 ANNEX TO RECOMMENDATION (Continued)

SPACE-TO-EARTH PATH PERFORMANCE

- (16a) *Weather Avail (%)*: The amount of time that the space-to-Earth link must be available when considering the degradation due to weather, expressed as a percent.
- (16b) *S/C Distance (km)*: The distance, measured along a ray path, between the spacecraft transmitting antenna's radiation point and the Earth station receiving antenna's reference point, expressed in kilometers (km).

Earth Stations and Spacecraft

4.1.3 ANNEX TO RECOMMENDATION (Continued)

INPUT DATA SHEET FOR EARTH-TO-SPACE LINK

EARTH STATION (E/S) TRANSMITTING RF CARRIER CHANNEL PARAMETERS

- (1) *TRANSMITTER POWER*: That power actually produced at the transmitter power amplifier's output terminals, expressed as a positive or negative value in dBW ($10 \text{ Log}_{10} [\text{Watts}]$).
- (2) *TRANSMITTER FREQUENCY*: The unmodulated transmitter carrier frequency, expressed in Megahertz (MHz).
- (3) *ANTENNA GAIN (ITU/RR/154)*: "The ratio, usually expressed in decibels, of the power required at the input of a loss-free reference antenna to the power supplied to the input of the given antenna to produce, in a given direction, the same field strength or power flux-density at the same distance. When not specified otherwise, the gain refers to the direction of maximum radiation." In this application, the reference antenna is an isotropic antenna located in free space. The antenna's gain is expressed as a positive or negative value in dBi.

Placing the network's name (e.g., DSN) in the box to the right of Antenna Gain and the antenna's diameter (e.g., 70) in box to the right of the network in row 3 will cause the computer program to consult its data base for all required information regarding that station.

- (4) *ANTENNA CIRCUIT LOSS*: The attenuation in rf power occurring between the output terminals of the transmitting power amplifier and the point of electromagnetic radiation from that antenna, expressed as a negative value in dB.
- (5) *ANTENNA POINTING LOSS*: The reduction in signal power at the receiving antenna resulting from imperfect pointing of the transmitting antenna such that the actual ray path from transmitting antenna to receiving antenna differs from the optimum ray path containing the point of maximum transmitting antenna gain, expressed as a negative value in dB.

EARTH STATION (E/S) TRANSMITTING DATA CHANNEL PARAMETERS

- (6) *INFORMATION BIT RATE*: The rate at which uncoded Telecommand information bits are to be sent from the transmitting station to the receiving station, expressed in bits per second (b/s).
- (7) *SUBCARRIER FREQUENCY*: The unmodulated Telecommand subcarrier's frequency, either 8 kHz or 16 kHz, expressed in kHz.
- (8) *SUBCARRIER WAVEFORM*: The Telecommand subcarrier's waveform is always sine wave.
- (9) *RF MODULATION INDEX*: The angle by which the rf carrier is phase shifted, with respect to the unmodulated rf carrier, as a result of the data on Telecommand channel of the modulator, expressed in radians peak.

Earth Stations and Spacecraft

4.1.3 ANNEX TO RECOMMENDATION (Continued)

EARTH STATION (E/S) TRANSMITTING RANGING CHANNEL PARAMETERS

- (10) *SIMULTANEOUS WITH DATA*: A statement showing whether the computed performance is based upon simultaneous ranging and telecommanding operations (e.g., Yes or No).
- (11) *RANGING WAVEFORM*: The waveform of the ranging modulation, sine wave for tone modulation, square wave for code modulation, expressed as Sin or Sq.
- (12a) *MOD INDEX TONE / CODE 1*: The angle by which the rf carrier is phase shifted, with respect to the unmodulated rf carrier, as a result of the highest frequency (major) ranging Tone / Code modulation, expressed in radians peak (Rad-pk).
- (12b) *MOD INDEX TONE / CODE 2*: The angle by which the rf carrier is phase shifted, with respect to the unmodulated rf carrier, as a result of the lower frequency (minor) ranging Tones / Codes modulation, expressed in radians peak (Rad-pk).

EARTH-TO-SPACE PATH PARAMETERS

- (13) *TOPOCENTRIC RANGE*: The distance, measured along a ray path, between the Earth station transmitting antenna's radiation point and the spacecraft receiving antenna's reference point, expressed in kilometers (km).
- (14) *ATMOSPHERIC ATTENUATION*: The reduction in signal power at the receiving antenna, considering such factors as the Earth station's antenna elevation angle, weather, and geographical location, which results from absorption, reflection, and scattering of the rf signal as it passes through the Earth's atmosphere, expressed as a negative value in dB.
- (15) *IONOSPHERIC LOSS*: The reduction in signal power at the receiving antenna, considering such factors as the Earth station's elevation angle and communication's frequency, resulting from the dispersive loss in radiated signal as it passes through the Ionosphere of the Earth and/or other bodies, expressed as a negative value in dB.
- (16) *ANTENNA ELEVATION ANGLE*: The angle between a ray, representing the boresight of the Earth-station's antenna beam pattern, and a locally horizontal line, when both ray and line are contained in a vertical plane which also contains the center of the Earth, expressed in degrees (deg).

SPACECRAFT (S/C) RECEIVING CARRIER RF CHANNEL PARAMETERS

- (17) *ANTENNA GAIN*: The ratio of the power flux density required at the input of a loss-free isotropic antenna to that power flux density needed at the input of the spacecraft's receiving antenna which produces the same output at the antenna's terminals for a source which is at equal distance from both antennas. The gain of the spacecraft's receiving antenna refers to the direction of maximum sensitivity, except in the case of a non-directional antenna in which case the gain refers to a minimum value corresponding to the antenna's specified coverage. The gain of the subject antenna, at the receiving frequency, is expressed as a positive or negative value in dBi.

Earth Stations and Spacecraft

4.1.3 ANNEX TO RECOMMENDATION (Continued)

- (18) *POLARIZATION LOSS*: The reduction in transferred signal power between transmitting and receiving stations resulting from differences in the radiated and received polarization patterns between the two antennas, expressed as a negative value in dB.
- (19) *ANTENNA POINTING LOSS*: Same definition as (5) above except that it is applicable to the pointing error of the spacecraft's receiving antenna, expressed as a negative value in dB.
- (20) *ANTENNA CIRCUIT LOSS*: The attenuation in rf power occurring between the point of electromagnetic radiation on the spacecraft's antenna and the input terminals of the low noise amplifier, expressed as a negative value in dB.
- (21) *CARRIER CIRCUIT LOSS*: The sum of resistive (cable and circuitry), transmission line mismatches, and other implementation losses, expressed as a negative value in dB.
- (22) *TOTAL NOISE TEMPERATURE*: The sum of the following noise temperature components (a) + (b) + (c). expressed in dBK. ***This sum is a computed entry and is not supplied by the user.***
- (a) *Receiver Operating Temp*: Overall Noise Temperature (CCIR/Rec 573-1): "For an antenna, or a receiving system including the antenna, the value to which the temperature of the resistive component of the source impedance should be brought, if it were the only source of noise, to cause the noise power at the output of the receiver to be the same as in real case."
- In the Link Design Control Table, this parameter represents a receiving system reference temperature, at the received frequency, which excludes all contributions enumerated in (b), and (c), below, expressed in Kelvin. The reference temperature is measured at the input to the low-noise amplifier with the antenna viewing a cold sky background and which includes contributions from the: 1) cosmic background; 2) low noise amplifier and/or receiver; 3) circuit losses before the low-noise amplifier and/or receiver.
- (b) *Feed Through Noise*: The increase in the receiver's operating temperature resulting from a portion of the transmitted signal leaking into the receiver's low-noise amplifier, expressed in Kelvin (K).
- (c) *Hot Body Noise*: The predicted increase from the reference temperature (T_r), resulting from the receiving antenna being directed toward a body having a temperature greater than that of the cold sky reference, expressed in Kelvin (K).
- (23) *THRESHOLD LOOP NOISE BW*: The total (2-sided) bandwidth of the rf carrier's phase-locked-loop, measured at the point when the SNR in that phase-locked-loop is +10 dB (carrier threshold), expressed in Hz.
- (24) *REQD THRESHOLD SNR IN 2 B_{LO}*: The ratio of received carrier power in 2 B_{LO} to the noise power density required to maintain receiver lock at threshold which has been defined to be +10 dB, expressed as a positive or negative value in dB.

Earth Stations and Spacecraft

4.1.3 ANNEX TO RECOMMENDATION (Continued)

SPACECRAFT (S/C) RECEIVING DATA CHANNEL PARAMETERS

- (25) *PHASE JITTER LOSS*: The loss in symbol detection efficiency resulting from phase noise on the received rf carrier, which produces a non-orthogonal, noisy phase relationship between the demodulator's reference and the rf carrier to be demodulated, plus losses from the partial tracking of the modulated symbols by the rf carrier phase locked loop, expressed as a negative value in dB.
- (26) *DEMODULATOR / DETECTOR LOSS*: The loss in data demodulation and detection efficiency resulting from phase noise on the demodulated subcarrier, which produces a non-orthogonal, noisy phase relationship between the demodulator's reference and the subcarrier to be demodulated, plus losses from the partial tracking of the data bits by the subcarrier loop, plus losses due to timing errors in the symbol synchronizer's tracking loop, plus losses from non-linearities in the demodulator, which reduce the device's efficiency, expressed as a negative value in dB.
- (27) *WAVEFORM DISTORTION LOSS*: The loss in the recovered data signal power resulting from distortion in the modulated signal's (subcarrier and data) waveform, which has been introduced by filtering and non-linearities in the data channel or medium, expressed as a negative value in dB.
- (28) *MAX RNG INTERFERENCE TO DATA*: The ratio of the ranging modulation's maximum spectral power level, lying within the data spectrum bandwidth [*data spectrum bandwidth equals the data symbol rate in Hz*], to the total ranging power level, expressed as a negative value in dB.
- (29) *REQUIRED DATA E_b/N_o* : The energy per data bit divided by the noise spectral density which is required to obtain the stated Bit Error Rate, considering the improvement due to coding, expressed in dB.

SPACECRAFT (S/C) RECEIVING RANGING (RNG) CHANNEL PARAMETERS

- (30) *RANGING DEMODULATOR LOSS*: The loss in ranging demodulation and detection efficiency resulting from phase noise on the demodulated subcarrier, which produces a non-orthogonal, noisy phase relationship between the demodulator's reference and the i.f. carrier to be demodulated, plus losses from non-linearities in the demodulator, which reduce the device's efficiency, expressed as a negative value in dB.
- (31) *RANGING FILTER BANDWIDTH*: The bandwidth of the ranging channel filter in the spacecraft receiver, expressed in Megahertz (MHz).
- (32) *REQUIRED TONE/CODE 1 SNR*: The ranging tone/code 1 signal-to-noise ratio required in the spacecraft's transponder to achieve the desired ranging measurement accuracy, expressed as a positive or negative number in dB.
- (33) *REQUIRED TONE/CODE 2 SNR*: The ranging tone/code 2 signal-to-noise ratio required in the spacecraft's transponder to achieve the desired ranging ambiguity resolution, expressed as a positive or negative number in dB.

Earth Stations and Spacecraft

4.1.3 ANNEX TO RECOMMENDATION (Continued)

INPUT DATA SHEET FOR SPACE-TO-EARTH LINK

SPACECRAFT (S/C) TRANSMITTING RF CARRIER CHANNEL PARAMETERS

- (51) *TRANSMITTER POWER*: That power actually produced at the transmitter power amplifier's output terminals, expressed as a positive or negative value in dBW (10Log_{10} [Watts]).
- (52) *TRANSMITTER FREQUENCY*: The unmodulated transmitter carrier frequency, expressed in Megahertz.
- (53) *ANTENNA GAIN*: The ratio of the power required at the input terminals of a loss-free isotropic antenna to the power supplied to the input terminals of the spacecraft's transmitting antenna which is needed to produce, in a specified direction, the same field strength (power flux density at an equivalent distance). The gain refers to the direction of maximum radiation except for non-directional antennas, in which case, the gain refers to a minimum value corresponding to the specified antenna coverage. The gain of the subject antenna, at the transmitting frequency, is expressed as a positive or negative value in dBi.
- (54) *ANTENNA CIRCUIT LOSS*: The attenuation in rf power occurring between the output terminals of the transmitting power amplifier and the point of electromagnetic radiation from that antenna, expressed as a negative value in dB.
- (55) *ANTENNA POINTING LOSS*: The reduction in signal power at the receiving antenna resulting from imperfect pointing of the transmitting antenna such that the actual ray path from transmitting antenna to receiving antenna differs from the optimum ray path containing the point of maximum transmitting antenna gain, expressed as a negative value in dB.

SPACECRAFT (S/C) TRANSMITTING DATA CHANNEL PARAMETERS

- (56) *INFORMATION BIT RATE*: The basic telemetry data rate generated by the flight data system, prior to any encoding or spectrum spreading procedures, for transmission to the receiving Earth station, expressed in kilo-bits per second (kb/s).
- (57) *SUBCARRIER FREQUENCY*: The unmodulated Telemetry subcarrier's frequency, expressed as a positive value in kilo-Hertz (kHz).
- (58) *SUBCARRIER WAVEFORM*: The waveform of the Telemetry subcarrier, either sine wave or square wave, expressed as Sin or Sq.
- (59) *RF MODULATION INDEX*: The angle by which the rf carrier is phase shifted, with respect to the unmodulated rf carrier, as a result of the data on Telemetry channel of the modulator, expressed in radians peak.

Earth Stations and Spacecraft

4.1.3 ANNEX TO RECOMMENDATION (Continued)

SPACECRAFT (S/C) TRANSMITTING RANGING (RNG) CHANNEL PARAMETERS

- (60) *SIMULTANEOUS WITH DATA*: A statement showing whether or not the computed performance is based upon simultaneous ranging and telemetry operations (e.g., Yes or No).
- (61) *MOD INDEX TONE / CODE*: The angle by which the rf carrier is phase shifted, with respect to the unmodulated rf carrier, as a result of the ranging Tones / Codes modulation, expressed in radians peak (Rad-pk).

SPACE-TO-EARTH PATH PARAMETERS

- (62) *TOPOCENTRIC RANGE*: The distance, measured along a ray path, between the spacecraft antenna's radiation point and ground station antenna's reference point, expressed in kilometers (km).
- (63) *ATMOSPHERIC ATTENUATION*: The reduction in signal power at the receiving antenna, considering such factors as the Earth station's antenna elevation angle, weather, and geographical location, which results from absorption, reflection, and scattering of the rf signal as it passes through the Earth's atmosphere, expressed as a negative value in dB.
- (64) *IONOSPHERIC LOSS*: The reduction in signal power at the receiving antenna, considering such factors as the Earth station's elevation angle and communication's frequency, resulting from the dispersive loss in radiated signal as it passes through the Ionosphere of the Earth and/or other bodies, expressed as a negative value in dB.
- (65) *ANTENNA ELEVATION ANGLE*: The angle between a ray, representing the boresight of the Earth-station's antenna beam pattern, and a locally horizontal line, when both ray and line are contained in a vertical plane which also contains the center of the Earth, expressed in degrees (Deg).

EARTH STATION (E/S) RECEIVING RF CARRIER CHANNEL PARAMETERS

- (66) *ANTENNA GAIN*: Same definition as (3) above except that it is applicable to the Earth station's receiving frequency. See second paragraph of (3) above to access Earth station data base.
- (67) *POLARIZATION LOSS*: The reduction in transferred signal power between transmitting and receiving stations resulting from differences in the radiated and received polarization patterns between the two antennas, expressed as a negative value in dB.
- (68) *ANTENNA POINTING LOSS*: Same definition as (5) above except that it is applicable to the pointing error of the Earth station's receiving antenna.
- (69) *ANTENNA CIRCUIT LOSS*: The attenuation in rf power occurring between the point of electromagnetic radiation on the Earth station's antenna and the input terminals of the low noise amplifier, expressed as a negative value in dB.

Earth Stations and Spacecraft

4.1.3 ANNEX TO RECOMMENDATION (Continued)

(70) *TOTAL NOISE TEMPERATURE*: The sum of the following noise temperature components (a) + (b) + (c) + (d), expressed in dBK. ***This sum is a computed entry and is not supplied by the user.***

- (a) *Receiver Operating Temp*: Overall Noise Temperature (CCIR/Rec 573-1): “For an antenna, or a receiving system including the antenna, the value to which the temperature of the resistive component of the source impedance should be brought, if it were the only source of noise, to cause the noise power at the output of the receiver to be the same as in real case.”

In the Link Design Control Table, this parameter represents a receiving system reference temperature, at the received frequency, which excludes all contributions enumerated in (b), and (c), below, expressed in Kelvin. The reference temperature is measured at the input to the low-noise amplifier with the antenna viewing a cold sky background and which includes contributions from the: 1) cosmic background; 2) low noise amplifier and/or receiver; 3) circuit losses before the low noise amplifier and/or receiver.

- (b) *Feed Through Noise*: The increase in the receiver’s operating temperature resulting from a portion of the transmitted signal leaking into the receiver’s low-noise amplifier, expressed in Kelvin (K).
- (c) *Hot Body Noise*: The predicted increase from the reference temperature (T_r), resulting from the receiving antenna being directed toward a body having a temperature greater than that of the cold sky reference, expressed in Kelvin (K).
- (d) *Weather Temp Increase*: The predicted increase from the reference temperature, resulting from the selected ground station weather model, and which excludes contributions from Atmospheric Attenuation (63), Ionospheric Loss (64), and from (b) and (c) above, expressed as a positive value in Kelvin.

(71) *THRESHOLD LOOP NOISE BW*: The total (2-sided) bandwidth of the rf carrier phase-locked-loop, measured at carrier threshold, expressed in Hz.

(72) *REQD THRESHOLD SNR IN 2 B_{LO}*: The ratio of received carrier power in 2 B_{LO} to the noise power density required to maintain receiver lock at threshold which has been defined to be +10 dB, expressed in dB.

Earth Stations and Spacecraft

4.1.3 ANNEX TO RECOMMENDATION (Continued)

EARTH STATION (E/S) RECEIVING DATA CHANNEL PARAMETERS

- (73) *PHASE JITTER LOSS*: The loss in symbol detection efficiency resulting from phase noise on the received rf carrier, which produces a non-orthogonal, noisy phase relationship between the demodulator's reference and the rf carrier to be demodulated, plus losses from the partial tracking of the modulated symbols by the rf carrier phase locked loop, expressed as a negative value in dB.
- (74) *DEMODULATOR / DETECTOR LOSS*: The loss in data demodulation and detection efficiency resulting from phase noise on the demodulated subcarrier, if any, which produces a non-orthogonal, noisy phase relationship between the demodulator's reference and the subcarrier to be demodulated, plus losses from the partial tracking of the data bits by the subcarrier loop, plus losses due to timing errors in the symbol synchronizer's tracking loop, plus losses from non-linearities in the demodulator, which reduce the device's efficiency, expressed as a negative value in dB.
- (75) *WAVEFORM DISTORTION LOSS*: The loss in the recovered data signal power, which results from distortion in the modulated signal's (subcarrier and data) waveform, which has been introduced by non-linearities in the data channel or medium, expressed as a negative value in dB.
- (76) *MAX RNG INTERFERENCE TO DATA*: The ratio of the ranging modulation's maximum spectral power level, lying within the data spectrum bandwidth [*data spectrum bandwidth equals the data symbol rate in Hz*], to the total ranging power level, expressed as a negative value in dB.
- (77) *REQUIRED DATA E_b/N_o* : The energy per data bit divided by the noise spectral density which is required to obtain the stated Bit Error Rate, considering the improvement due to coding, expressed in dB.

EARTH STATION (E/S) RECEIVING RANGING (RNG) CHANNEL PARAMETERS

- (78) *RANGING DEMODULATOR LOSS*: The loss in ranging demodulation and detection efficiency resulting from phase noise on the demodulated subcarrier, which produces a non-orthogonal, noisy phase relationship between the demodulator's reference and the i.f. carrier to be demodulated, plus losses from non-linearities in the demodulator, which reduce the device's efficiency, expressed as a negative value in dB.
- (79) *REQUIRED TONE/CODE 1 PWR/ N_o* : The magnitude of range tone/code 1 ST/N_o required to achieve the desired Range accuracy, expressed as a positive or negative value in dB-Hz.
- (80) *REQUIRED TONE/CODE 2 PWR/ N_o* : The magnitude of range tone/code 2 ST/N_o required to achieve the desired probability of error in the ranging measurement, expressed as a positive or negative value in dB-Hz.

Earth Stations and Spacecraft

4.1.3 ANNEX TO RECOMMENDATION (Continued)

LINK COMPUTATIONS FOR EARTH-TO-SPACE LINK

EARTH STATION (E/S) TRANSMITTING RF CARRIER CHANNEL PERFORMANCE

- (101) *TRANSMITTER POWER*: That power actually produced at the transmitter power amplifier's output terminals, expressed as a positive or negative value in dBW ($10 \text{ Log}_{10} [\text{Watts}]$).
- (102) *TRANSMIT ANTENNA GAIN [Effect]*: The computed antenna gain found by subtracting the Antenna Circuit Loss and Antenna Pointing Loss from the Antenna Gain [(3)]-[(4)+(5)], expressed as a positive or negative value in dBi.
- (103) *TRANSMIT EIRP*: The computed effective isotropically radiated power found by adding Transmitter Power and Effective Antenna Gain [(101)+(102)], expressed as a positive or negative value in dBW.
- (104) *TRANSMIT CARRIER POWER*: The computed portion of the total transmitted power remaining in the rf carrier channel after subtracting the power in the sidebands due to the modulating signals, expressed as a positive or negative value in dBW.
- (105) *TRANSMIT CARRIER POWER / P_T* : The power computed in (104) above, divided by the total Earth station transmitted power, expressed as a negative value in dB.

EARTH STATION (E/S) TRANSMITTING DATA CHANNEL PERFORMANCE

- (106) *TRANSMIT CH 1 DATA POWER*: The computed power in the rf carrier's data sidebands resulting from the modulating signal on data Channel 1, expressed as a positive or negative value in dBW.
- (107) *TRANSMIT CH 1 DATA POWER / P_T* : The Channel 1 data power computed in (106) above, divided by the total Earth station transmitted power, expressed as a negative value in dB.
- (108) *TRANSMIT CH 2 DATA POWER*: The computed power in the rf carrier's data sidebands resulting from the modulating signal on data Channel 2, expressed as a positive or negative value in dBW.
- (109) *TRANSMIT CH 2 DATA POWER / P_T* : The Channel 2 data power computed in (108) above, divided by the total Earth station transmitted power, expressed as a negative value in dB.

EARTH STATION (E/S) TRANSMITTING RANGING (RNG) CHANNEL PERFORMANCE

- (110) *TONE - CODE 1 POWER*: The computed power in the rf carrier's ranging sidebands resulting from either Tone 1 (major) or Code 1 modulation, expressed as a positive or negative value in dBW.
- (111) *TONE - CODE 1 POWER / P_T* : The Tone or Code 1 power computed in (110) above, divided by the total Earth station transmitted power, expressed as a negative value in dB.

Earth Stations and Spacecraft

4.1.3 ANNEX TO RECOMMENDATION (Continued)

- (112) *TONE - CODE 2 POWER*: The computed power in the rf carrier's ranging sidebands resulting from either Tone 2 (minor) or Code 2 modulation, expressed as a positive or negative value in dBW.
- (113) *TONE - CODE 2 POWER / P_T*: The Tone or Code 2 power computed in (112) above, divided by the total Earth station transmitted power, expressed as a negative value in dB.

EARTH-TO-SPACE PATH PERFORMANCE

- (114) *FREE SPACE LOSS*: The computed loss resulting from the spreading of the signal as it propagates from transmitting to receiving stations, expressed as a negative value in dB.
- (115) *ATMOSPHERIC ATTENUATION*: The reduction in signal power at the receiving antenna, considering such factors as the Earth station's antenna elevation angle, weather, and geographical location, which results from absorption, reflection, and scattering of the rf signal as it passes through the Earth's atmosphere, placed on this page for reference purposes, expressed as a negative value in dB.
- (116) *IONOSPHERIC LOSS*: The reduction in signal power at the receiving antenna, considering such factors as the Earth station's elevation angle and communication's frequency, resulting from the dispersive loss in radiated signal as it passes through the Ionosphere of the Earth and/or other bodies, placed on this page for reference purposes, expressed as a negative value in dB.

SPACECRAFT (S/C) RECEIVING RF CARRIER CHANNEL PERFORMANCE

- (117) *RECEIVING ANTENNA GAIN [Effect]*: The computed antenna gain found by subtracting the Polarization Loss, Antenna Pointing Loss, and Antenna Circuit Loss from the Antenna Gain (17)-[(18)+(19)+(20)], expressed as a positive or negative value in dBi.
- (118) *NOISE SPECTRAL DENSITY*: The computed noise, generally resulting from the receiver's low noise amplifier, in a 1 Hz bandwidth, expressed in dBW/Hz.
- (119) *THRESHOLD LOOP BW, 2 B_{LO}*: Same definition as (24) above, placed on this page for reference purposes.
- (120) *RECEIVED CARRIER POWER*: The computed carrier power in the receiver's phase locked loop bandwidth of 2 B_{LO}, expressed as a positive or negative value in dBW.
- (121) *CARRIER PERFORMANCE MARGIN*: The computed excess in rf carrier signal over +10 dB SNR in the phase-locked-loop, which is defined to be carrier threshold, expressed in dB.

Earth Stations and Spacecraft

4.1.3 ANNEX TO RECOMMENDATION (Continued)

SPACECRAFT (S/C) RECEIVING DATA CHANNEL PERFORMANCE

- (122) *CH 1 DATA LOSS DUE TO RNG*: The computed loss in data channel's performance resulting from the presence of a simultaneous ranging signal on the Earth-to-space link, expressed in dB.
- (123) *RECEIVED CH 1 E_b / N_o* : The computed received energy per bit in Data Channel 1 divided by the noise spectral density, expressed in dB.
- (124) *REQUIRED CH 1 E_b / N_o* : The computed energy per bit divided by the noise spectral density (E_b / N_o) found by adding the Phase Jitter Loss, Demodulator/Detector Loss, Waveform Distortion Loss, and Maximum Ranging Interference to Data to the Required Data E_b / N_o [(29)] + [(25)+(26)+(27)+(28)], expressed in dB.
- (125) *CH 1 DATA PERFORMANCE MARGIN*: The computed excess of Channel 1 received E_b / N_o over the required E_b / N_o , [(123)-(124)], expressed in dB.
- (126) *CH 2 DATA LOSS DUE TO RNG*: Same definition as (122) above except that it is applicable to data channel 2.
- (127) *RECEIVED CH 2 E_b / N_o* : Same definition as (123) above except that it is applicable to data channel 2.
- (128) *REQUIRED CH 2 E_b / N_o* : Same definition as (124) above except that it is applicable to data channel 2.
- (129) *CH 2 DATA PERFORMANCE MARGIN*: The computed excess of Channel 2 received E_b / N_o over the required E_b / N_o , [(127)-(128)], expressed in dB.

SPACECRAFT (S/C) RECEIVING RANGING (RNG) CHANNEL PERFORMANCE

- (130) *RECEIVED CODE 1 POWER / N_o* : The computed received power (P_R) in the ranging Tone 1 (major) or Code 1 divided by the noise spectral density, expressed as a positive or negative value in dB-Hz.
- (131) *RECEIVED CODE 2 POWER / N_o* : Same definition as (130) above except that it is applicable to Tone or Code 2.
- (132) *RECEIVED TOTAL RNG POWER / N_o* : The computed total received power in all ranging Tones or Codes, if several are present simultaneously, or Tone/Code 1 if Tones or Codes are transmitted sequentially, divided by the noise spectral density, expressed as a positive or negative value in dB-Hz.
- (133) *RANGING MARGIN*: The computed excess of received total ranging power over the required ranging power, expressed in dB.

Earth Stations and Spacecraft

4.1.3 ANNEX TO RECOMMENDATION (Continued)

LINK COMPUTATIONS FOR SPACE-TO-EARTH LINK

SPACECRAFT (S/C) TRANSMITTING RF CARRIER CHANNEL PERFORMANCE

- (151) *TRANSMITTER POWER*: That power actually produced at the transmitter power amplifier's output terminals, expressed as a positive or negative value in dBW ($10 \text{ Log}_{10} [\text{Watts}]$).
- (152) *TRANSMIT ANTENNA GAIN [Effect]*: The computed antenna gain found by subtracting the Antenna Circuit Loss and Antenna Pointing Loss from the Antenna Gain (53)-[(54)+(55)], expressed as a positive or negative value in dBi.
- (153) *TRANSMIT EIRP*: The computed effective isotropically radiated power found by adding Transmitter Power and Effective Antenna Gain [(151)+(152)], expressed as a positive or negative value in dBW.
- (154) *TRANSMIT CARRIER POWER*: The computed portion of the total transmitted power remaining in the rf carrier channel after subtracting the power in the sidebands due to the modulating signals, expressed as a positive or negative value in dBW.
- (155) *TRANSMIT CARRIER POWER / P_T* : The power computed in (154) above, divided by the total spacecraft transmitted power, expressed as a negative value in dB.

SPACECRAFT (S/C) TRANSMITTING DATA CHANNEL PERFORMANCE

- (156) *TRANSMIT CH 1 DATA POWER*: The computed power in the rf carrier's data sidebands resulting from the modulating signal on data Channel 1, expressed as a positive or negative value in dBW.
- (157) *TRANSMIT CH 1 DATA POWER / P_T* : The Channel 1 data power computed in (156) above, divided by the total spacecraft transmitted power, expressed as a negative value in dB.
- (158) *TRANSMIT CH 2 DATA POWER*: The computed power in the rf carrier's data sidebands resulting from the modulating signal on data Channel 2, expressed as a positive or negative value in dBW.
- (159) *TRANSMIT CH 2 DATA POWER / P_T* : The Channel 2 data power computed in (158) above, divided by the total spacecraft transmitted power, expressed as a negative value in dB.

SPACECRAFT (S/C) TRANSMITTING RANGING (RNG) CHANNEL PERFORMANCE

- (160) *TONE - CODE 1 POWER*: The computed power in the rf carrier's ranging sidebands resulting from either Tone 1 (major) or Code 1 modulation, expressed as a positive or negative value in dBW.
- (161) *TONE - CODE 1 POWER / P_T* : The Tone or Code 1 power computed in (160) above, divided by the total Earth station transmitted power, expressed as a negative value in dB.

Earth Stations and Spacecraft

4.1.3 ANNEX TO RECOMMENDATION (Continued)

- (162) *TONE - CODE 2 POWER*: The computed power in the rf carrier's ranging sidebands resulting from either Tone 2 (major) or Code 2 modulation, expressed as a positive or negative value in dBW.
- (163) *TONE - CODE 2 POWER / P_T*: The Tone or Code 2 power computed in (162) above, divided by the total spacecraft transmitted power, expressed as a negative value in dB.

SPACE-TO-EARTH PATH PERFORMANCE

- (164) *FREE SPACE LOSS*: The computed loss resulting from the spreading of the signal as it propagates from transmitting to receiving station, expressed as a negative value in dB.
- (165) *ATMOSPHERIC ATTENUATION*: The reduction in signal power at the receiving antenna, considering such factors as the Earth station's antenna elevation angle, weather, and geographical location, which results from absorption, reflection, and scattering of the rf signal as it passes through the Earth's atmosphere, placed on this page for reference purposes, expressed as a negative value in dB.
- (166) *IONOSPHERIC LOSS*: The reduction in signal power at the receiving antenna, considering such factors as the Earth station's elevation angle and communication's frequency, resulting from the dispersive loss in radiated signal as it passes through the Ionosphere of the Earth and/or other bodies, placed on this page for reference purposes, expressed as a negative value in dB.

EARTH STATION (E/S) RECEIVING RF CARRIER CHANNEL PERFORMANCE

- (167) *RECEIVING ANTENNA GAIN [Effect]*: The computed antenna gain found by subtracting the Polarization Loss, Antenna Pointing Loss, and Antenna Circuit Loss from the Antenna Gain (66) - [(67) + (68) + (69)], expressed as a positive or negative value in dBi.
- (168) *NOISE SPECTRAL DENSITY*: The computed noise, generally resulting from the receiver's low noise amplifier, in a 1 Hz bandwidth, expressed in dBW/Hz.
- (169) *THRESHOLD LOOP BW, 2 B_{LO}*: Same definition as (71) above, placed on this page for reference purposes.
- (170) *RECEIVED CARRIER POWER*: The computed carrier power in the receiver's phase locked loop bandwidth of 2 B_{LO}, expressed in dBW.
- (171) *CARRIER PERFORMANCE MARGIN*: The computed excess in rf carrier signal over +10 dB SNR in the phase-locked-loop, which is defined to be carrier threshold, expressed in dB.

Earth Stations and Spacecraft

4.1.3 ANNEX TO RECOMMENDATION (Continued)

EARTH STATION (E/S) RECEIVING DATA CHANNEL PERFORMANCE

- (172) *CH 1 DATA LOSS DUE TO RNG*: The computed loss in data channel's performance resulting from the presence of a simultaneous ranging signal on the space-to-Earth link, expressed in dB.
- (173) *RECEIVED CH 1 E_b / N_o* : The computed received energy per bit in Data Channel 1 divided by the noise spectral density, expressed in dB.
- (174) *REQUIRED CH 1 E_b / N_o* : The computed energy per bit divided by the noise spectral density (E_b / N_o) found by adding the Phase Jitter Loss, Demodulator/Detector Loss, Waveform Distortion Loss, and Maximum Ranging Interference to Data to the Required Data E_b / N_o [(77)] + [(73)+(74)+(75)+(76)], [includes the improvement due to coding], expressed in dB.
- (175) *CH 1 DATA PERFORMANCE MARGIN*: The computed excess of Channel 1 received E_b / N_o over the required E_b / N_o , [(173)-(174)], expressed in dB.
- (176) *CH 2 DATA LOSS DUE TO RNG*: Same definition as (172) above except that it is applicable to data channel 2.
- (177) *RECEIVED CH 2 E_b / N_o* : Same definition as (173) above except that it is applicable to data channel 2.
- (178) *REQUIRED CH 2 E_b / N_o* : Same definition as (174) above except that it is applicable to data channel 2.
- (179) *CH 2 DATA PERFORMANCE MARGIN*: The computed excess of Channel 2 received E_b / N_o over the required E_b / N_o , [(177)-(178)], expressed in dB.

EARTH STATION (E/S) RECEIVING RANGING (RNG) CHANNEL PERFORMANCE

- (180) *RECEIVED CODE 1 POWER / N_o* : The computed received power (P_R) in the ranging Tone 1 (major) or Code 1 divided by the noise spectral density, expressed as a positive or negative value in dB-Hz.
- (181) *RECEIVED CODE 2 POWER / N_o* : Same definition as (180) above except that it is applicable to Tone or Code 2.
- (182) *RECEIVED TOTAL RNG POWER / N_o* : The computed total received power in all ranging Tones or Codes, if several are present simultaneously, or Tone/Code 1 if Tones or Codes are transmitted sequentially, divided by the noise spectral density, expressed as a positive or negative value in dB-Hz.
- (183) *RANGING PERFORMANCE MARGIN*: The computed excess of received total ranging power over the required ranging power, expressed in dB.

Earth Stations and Spacecraft

**4.1.4 DEFAULT PROBABILITY DENSITY FUNCTIONS FOR LINK COMPUTATION
IN THE CCSDS TELECOMMUNICATIONS LINK DESIGN CONTROL TABLE**

**The CCSDS,
considering**

- (a) that several parameters used in the telecommunications link Design Control Table (DCT) [*CCSDS Recommendation 401 (4.1.2) B-1*] are random variables whose values can only be estimated using statistical methods;
- (b) that such statistical computations require a knowledge of the statistical properties of the non-deterministic parameters;
- (c) that a Probability Density Function (PDF) is useful in representing the statistical properties of a random variable;
- (d) that the PDFs, shown in figure 4.1.4-1 of the Annex, are considered to be sufficient to estimate the statistical values of the parameters in the telecommunications link DCT;
- (e) that empirical evidence, obtained from many years of experience in telecommunication link design, demonstrates that the PDFs, published in References [1] and [2] and reproduced in Tables 4.1.4-1 and 4.1.4-2 of the Annex hereto, provide the best estimates of the statistical values for the named parameters;
- (f) that many of the non-deterministic parameters found in the CCSDS link DCT [*CCSDS Recommendation 401 (4.1.2) B-1*] are independent of the specific implementation methods used by agencies in their Earth stations and spacecraft while others are not;

recommends

- (1) that CCSDS agencies employ the three PDFs shown in figure 4.1.4-1 of the Annex to approximate the PDFs of parameters found in the CCSDS link DCT, when computing their statistical values;
- (2) that, **when a CCSDS Agency has not independently specified some, or all, of the PDFs**, the default set of PDFs shown in Tables 4.1.4-1 and 4.1.4-2 of the Annex hereto should be used to estimate the value of the correspondingly named parameter;
- (3) that, **where a CCSDS Agency has specified some, or all, of the PDFs for non-deterministic parameters**, either the Agency's set of PDFs or the default set of PDFs, found in Tables 4.1.4-1 and 4.1.4-2, may be used.

REFERENCES

- 1. Joseph Yuen, Editor, "Deep Space Telecommunications Systems Engineering," Plenum Press, New York, 1983, Chapter 1.
- 2. Joseph Yuen, "A Practical Statistical Model for Telecommunications Performance Uncertainty," Technical Memorandum 33-732, NASA/Jet Propulsion Laboratory, California Institute Of Technology, Pasadena, June 15, 1975.

Earth Stations and Spacecraft

4.1.4 DEFAULT PROBABILITY DENSITY FUNCTIONS FOR LINK COMPUTATION IN THE CCSDS TELECOMMUNICATIONS LINK DESIGN CONTROL TABLE (Continued)

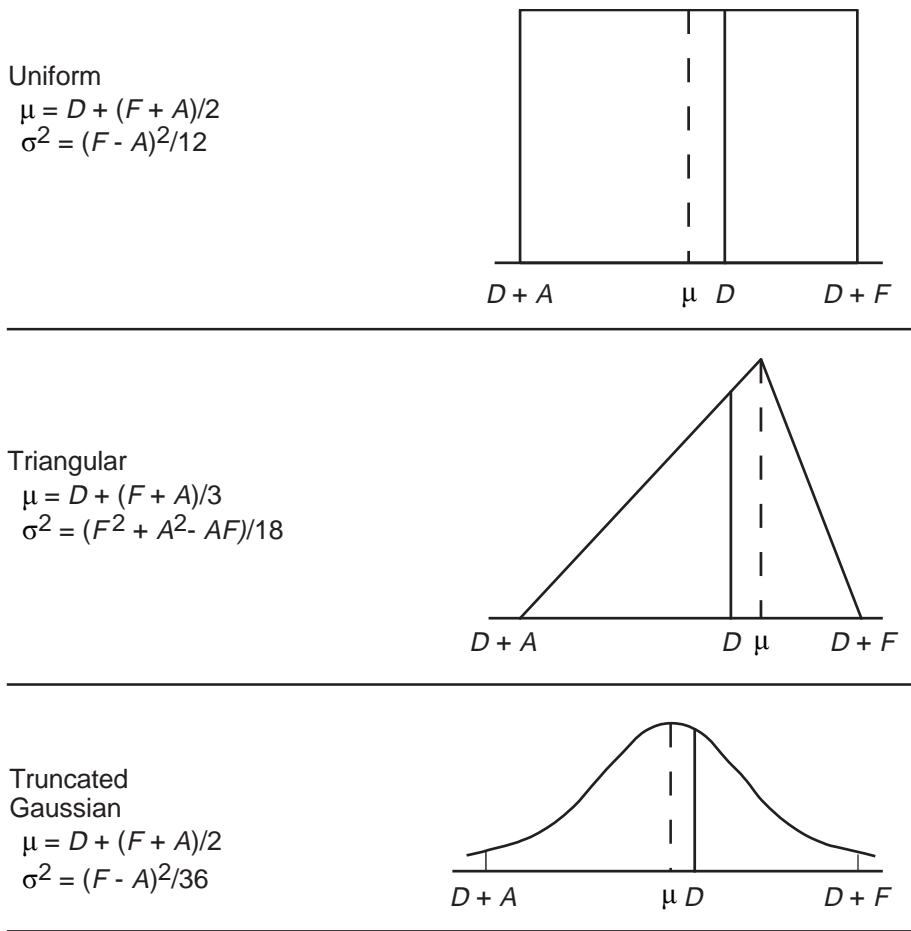

6445-442ab

Figure 4.1.4-1: Probability Density Functions

- D = Design value, in dB.
- μ = Mean value, in dB.
- σ^2 = Variance, in dB².
- A = Adverse tolerance, which is defined as the worst case of a parameter minus the design value in dB. Adverse tolerance generally has a negative value for all link parameters except noise spectral density and noise bandwidth.
- F = Favorable tolerance, which is defined as the best case of a parameter minus the design value in dB. Favorable tolerance generally has a positive value for all link parameters except noise spectral density and noise bandwidth.

NOTE: The above formulas assume that (D + A) and (D + F) are at ($\mu \pm 3\sigma$) points.

Earth Stations and Spacecraft

4.1.4 DEFAULT PROBABILITY DENSITY FUNCTIONS FOR LINK COMPUTATION IN THE CCSDS TELECOMMUNICATIONS LINK DESIGN CONTROL TABLE (Continued)

ANNEX

TABLE 4.1.4-1: EARTH-TO-SPACE (UPLINK) DATA ELEMENT TYPES

Element Number	Description	Probability Density Function
3	Antenna Gain	Uniform
4	Antenna Circuit Loss (TX)	Uniform
5	Antenna Pointing Loss (TX)	Uniform
17	S/C Antenna Gain	Triangular
18	Polarization Loss (RX)	Uniform
19	S/C Antenna Pointing Loss (RX)	Triangular
20	S/C Antenna Circuit Loss (RX)	Uniform
21	Carrier Circuit Loss	Triangular
25	Phase Jitter Loss	Uniform
26	Demodulator/Detector Loss	Triangular
27	Waveform Distortion Loss	Uniform
28	Maximum Ranging Interference to Data	Deterministic
30	Ranging Demodulation Loss	Triangular
101	Station Transmitter Power	Triangular
102	Trans. Ant. Gain [Effective]	Uniform
103	Transmitting EIRP	Triangular
104	Transmitted Carrier Power	Triangular
105	Trans. Carrier Power/ P_T	Triangular
106	Trans. Chan. 1 Data Power	Triangular
107	Trans. Chan. 1 Data Power/ P_T	Triangular
108	Trans. Chan. 2 Data Power	Triangular
109	Trans. Chan. 2 Data Power/ P_T	Triangular
110	Tone - Code 1 Power	Triangular

Earth Stations and Spacecraft

4.1.4 DEFAULT PROBABILITY DENSITY FUNCTIONS FOR LINK COMPUTATION IN THE CCSDS TELECOMMUNICATIONS LINK DESIGN CONTROL TABLE (Continued)

ANNEX

TABLE 4.1.4-1: EARTH-TO-SPACE (UPLINK) DATA ELEMENT TYPES (Continued)

Element Number	Description	Probability Density Function
111	Tone - Code 1 Power/ P_T	Triangular
112	Tone - Code 2 Power	Triangular
113	Tone - Code 2 Power/ P_T	Triangular
114	Free Space Loss	Triangular
115	Atmospheric Attenuation	Gaussian
116	Ionospheric Loss	Gaussian
117	Receiving Antenna Gain [Effective]	Uniform
118	Noise Spectral Density	Gaussian
119	Threshold Loop BW, $2B_{LO}$	Triangular
120	Received Carrier Power	Triangular
121	Carrier Performance Margin	Triangular
122	Channel 1 Data Loss Due to Ranging	Triangular
123	Received Channel 1 E_b/N_o	Triangular
124	Required Channel 1 E_b/N_o	Deterministic
125	Channel 1 Data Performance Margin	Triangular
126	Channel 2 Data Loss Due to Ranging	Triangular
127	Received Channel 1 E_b/N_o	Triangular
128	Required Channel 2 E_b/N_o	Deterministic
129	Channel 2 Data Performance Margin	Triangular
130	Received Code 1 Power/ N_o	Triangular
131	Received Code 2 Power/ N_o	Triangular
132	Rcvd Total Ranging Power/ N_o	Triangular
133	Ranging Power at S/C Receiver Output (Uplink Ranging Margin)	Triangular

Earth Stations and Spacecraft

**4.1.4 DEFAULT PROBABILITY DENSITY FUNCTIONS FOR LINK COMPUTATION
 IN THE CCSDS TELECOMMUNICATIONS LINK DESIGN CONTROL TABLE
 (Continued)**

ANNEX

TABLE 4.1.4-2: SPACE-TO-EARTH (DOWNLINK) DATA ELEMENT TYPES

Element Number	Description	Probability Density Function
53	S/C Antenna Gain	Triangular
54	S/C Antenna Circuit Loss (TX)	Uniform
55	Antenna Pointing Loss (TX)	Triangular
66	E/S Antenna Gain	Uniform
67	Polarization Loss (RX)	Uniform
68	Antenna Pointing Loss (RX)	Uniform
69	Antenna Circuit Loss (RX)	Uniform
70a	Receiver Operating Temperature	Gaussian
70b	Feed Through Noise	Gaussian
70c	Hot Body Noise	Gaussian
70d	Weather Temperature Increase	Gaussian
73	Phase Jitter Loss	Uniform
74	Demodulator/Detector Loss	Triangular
75	Waveform Distortion Loss	Uniform
76	Maximum Ranging Interference to Data	Deterministic
78	Ranging Demodulation Loss	Triangular
151	S/C Transmitter Power	Triangular
152	Trans. Ant. Gain [Effective]	Uniform
153	Transmitting EIRP	Triangular
154	Transmitted Carrier Power	Triangular
155	Trans. Carrier Power/ P_T	Triangular
156	Trans. Chan. 1 Data Power	Triangular
157	Trans. Chan. 1 Data Power/ P_T	Triangular
158	Trans. Chan. 2 Data Power	Triangular

Earth Stations and Spacecraft

**4.1.4 DEFAULT PROBABILITY DENSITY FUNCTIONS FOR LINK COMPUTATION
 IN THE CCSDS TELECOMMUNICATIONS LINK DESIGN CONTROL TABLE
 (Continued)**

ANNEX

TABLE 4.1.4-2: SPACE-TO-EARTH (DOWNLINK) DATA ELEMENT TYPES (Continued)

Element Number	Description	Probability Density Function
159	Trans. Chan. 2 Data Power/ P_T	Triangular
160	Tone - Code 1 Power	Triangular
161	Tone - Code 1 Power/ P_T	Triangular
162	Tone - Code 2 Power	Triangular
163	Tone - Code 2 Power/ P_T	Triangular
164	Free Space Loss	Triangular
165	Atmospheric Attenuation	Gaussian
166	Ionospheric Loss	Gaussian
167	Receiving Antenna Gain [Effective]	Uniform
168	Noise Spectral Density	Gaussian
169	Threshold Loop BW, $2B_{LO}$	Triangular
170	Received Carrier Power	Triangular
171	Carrier Performance Margin	Gaussian
172	Chan. 1 Data Loss Due to Ranging	Triangular
173	Received Channel 1 E_b/N_o	Triangular
174	Required Channel 1 E_b/N_o	Deterministic
175	Channel 1 Data Performance Margin	Gaussian
176	Chan. 2 Data Loss Due to Ranging	Triangular
177	Received Channel 2 E_b/N_o	Triangular
178	Required Channel 2 E_b/N_o	Deterministic
179	Channel 2 Data Performance Margin	Gaussian
180	Received Code 1 Power/ N_o	Triangular
181	Received Code 2 Power/ N_o	Triangular
182	Rcvd Total Ranging Power/ N_o	Triangular
183	Ranging Margin	Gaussian

Earth Stations and Spacecraft

4.1.5 COMPUTATIONAL TECHNIQUE FOR THE MEAN AND VARIANCE OF THE MODULATION LOSSES FOUND IN THE CCSDS TELECOMMUNICATION LINK DESIGN CONTROL TABLE

**The CCSDS,
considering**

- (a) that the term “modulation loss” as used in the CCSDS Link Design Control Table (DCT) [CCSDS Recommendation 401 (4.1.2) B-1] means “that fraction of the total transmitted power allotted to a designated channel”;
- (b) that the computation of the carrier, telecommand, telemetry and ranging link margins found in the CCSDS DCT requires an evaluation of the modulation losses;
- (c) that the CCSDS DCT employs a statistical technique for computing the mean and variance of modulation losses for which most input parameters in the DCT require the specification of a design value together with its favorable and adverse tolerances;
- (d) that computation of the modulation loss tolerances are based upon variations at the peak phase deviations (peak modulation indices);
- (e) that the calculation of the variance on link performance can be tedious because it requires the designer to evaluate the several modulation losses for all possible combinations of favorable and adverse tolerances;
- (f) that, for systems employing a coherent-turnaround ranging channel with a constant-power AGC simultaneously with telecommand and telemetry (figure 4.1.5-1), there are 128 possible combinations of favorable and adverse tolerances affecting the several modulation losses which must be evaluated to compute the telemetry channel’s performance;
- (g) that computing a telecommunication system’s performance by evaluating all possible combinations of favorable and adverse tolerances on the several modulation loss input parameters results in an unnecessary increase in computational complexity since the combinations producing the extreme performance variations are deterministic;
- (h) that based on the mathematical expressions for the modulation losses, simple algorithms can be developed to avoid this unnecessary increase in computational complexity;
- (i) that, due to the modulation schemes recommended by the CCSDS, [CCSDS Recommendations 401 (2.2.2) B-1, 401 (2.2.3) B-1, 401 (2.3.1) B-1, 401 (2.4.2) B-1 and 401 (2.4.3) B-1], computation of tolerances on the several modulation losses requires the use of Bessel, trigonometric and exponential functions;
- (j) that, when the maximum modulation indices are less than 1.4 radians [see CCSDS Recommendations 401 (2.1.6) B-1 and 401 (2.3.8) B-2], the maximum and minimum values of some modulation losses do not occur when all modulation indices are simultaneously at their upper or lower bounds, respectively (see figure 4.1.5-2);

Earth Stations and Spacecraft

4.1.5 COMPUTATIONAL TECHNIQUE FOR THE MEAN AND VARIANCE OF THE MODULATION LOSSES FOUND IN THE CCSDS TELECOMMUNICATION LINK DESIGN CONTROL TABLE (Continued)

- (k) that a common set of computation algorithms will ease the information exchange between space agencies;

recommends

- (1) that parameters defined in Tables 4.1.5-1a and 4.1.5-1b be used in the formulas for the computation of the maxima and minima of the modulation losses;
- (2) that Algorithm 1 be used to compute the mean and variance of the Earth-to-space modulation losses for simultaneous range and telecommand operations using sinewave subcarriers;
- (3) that Algorithm 2 be used to compute the mean and variance of the space-to-Earth modulation losses when a power-controlled AGC is employed on the turnaround ranging channel.

Earth Stations and Spacecraft

4.1.5 COMPUTATIONAL TECHNIQUE FOR THE MEAN AND VARIANCE OF THE MODULATION LOSSES FOUND IN THE CCSDS TELECOMMUNICATION LINK DESIGN CONTROL TABLE (Continued)

ANNEX TO RECOMMENDATION 4.1.5

TABLE 4.1.5-1a: Definitions of Parameters in Uplink Modulation Loss Formulas

m_{CD} = telecommand peak modulation index;
 m_{R_1} = uplink peak ranging modulation index;
 P_{T_1} = total uplink signal power;
 P_{C_1}, P_{CD}, P_{R_1} = uplink carrier, telecommand and ranging powers, respectively;
 N_{01} = uplink noise power spectral density.

TABLE 4.1.5-1b: Definitions of Parameters in Downlink Modulation Loss Formulas

m_{TM1}, m_{TM2} = telemetry channels 1 and 2 peak modulation indices;
 m_{R_2} = downlink peak ranging modulation index;
 P_{T_2} = total downlink signal power;
 $P_{C_2}, P_{TM1}, P_{TM2}, P_{R_2}$ = powers of downlink carrier, of telemetry channels 1 and 2 and of ranging, respectively.

Ranging Modulation Type Coefficient: $\gamma = \frac{8}{\pi^2}$ if only the fundamental harmonic of an uplink ranging square wave signal passes through the transponder's ranging filter; $\gamma = 1$ if a sinusoidal ranging signal is modulated on the uplink carrier.

Actual (noise-modified) modulation indices for feed-through command (peak), ranging (peak) and noise (rms), respectively:

$$\tau_1 = m_{R_2} \sqrt{\frac{\alpha_C}{\alpha_C + \alpha_R + 1}}, \quad \tau_2 = m_{R_2} \sqrt{\frac{\alpha_R}{\alpha_C + \alpha_R + 1}}, \quad \tau_3 = \frac{m_{R_2}}{\sqrt{2(\alpha_C + \alpha_R + 1)}}$$

$\alpha_R = \frac{\gamma P_{R_1}}{N_{01} B_R}$: ranging signal-to-noise power ratio at the output of the transponder filter;

$\alpha_C = \left[\frac{P_{CD}/P_{T_1}}{P_{R_1}/P_{T_1}} \right] \alpha_R$: feed-through telecommand-to-noise power ratio at the transponder ranging filter's output (with no telecommand subcarrier attenuation);

B_R = one-sided bandwidth of the transponder ranging channel.

Earth Stations and Spacecraft

4.1.5 COMPUTATIONAL TECHNIQUE FOR THE MEAN AND VARIANCE OF THE MODULATION LOSSES FOUND IN THE CCSDS TELECOMMUNICATION LINK DESIGN CONTROL TABLE (Continued)

ANNEX TO RECOMMENDATION 4.1.5 (Continued)

ALGORITHM 1 : Computation of the Mean and Variance of Uplink Modulation Losses.

1. Compute the maxima and minima of uplink ranging and telecommand modulation indices by adding the favorable and adverse tolerances to the nominal values of the modulation indices.
2. Compute the nominal uplink modulation losses by substituting the nominal (design) modulation index values in the modulation loss equations in Table 4.1.5-2:

TABLE 4.1.5-2: Nominal Uplink Modulation Losses		
Channel	Square-Wave Ranging	Sinusoidal Ranging
Carrier	$\frac{P_{C_1}}{P_{T_1}} = \cos^2(m_{R_1})J_0^2(m_{CD})$	$\frac{P_{C_1}}{P_{T_1}} = J_0^2(m_{R_1})J_0^2(m_{CD})$
Telecommand	$\frac{P_{CD}}{P_{T_1}} = 2\cos^2(m_{R_1})J_1^2(m_{CD})$	$\frac{P_{CD}}{P_{T_1}} = 2J_0^2(m_{R_1})J_1^2(m_{CD})$
Ranging	$\frac{P_{R_1}}{P_{T_1}} = \sin^2(m_{R_1})J_0^2(m_{CD})$	$\frac{P_{R_1}}{P_{T_1}} = 2J_1^2(m_{R_1})J_0^2(m_{CD})$

3. Compute minima and maxima of uplink modulation losses using the equations of Table 4.1.5-3, as shown in Tables 4.1.5-3a and 4.1.5-3b:

TABLE 4.1.5-3a: Minima and Maxima of Uplink Modulation Losses / Square-Wave Ranging		
Carrier	$\left(\frac{P_{C_1}}{P_{T_1}}\right)_{\max} = \cos^2(m_{R_1}(\min))J_0^2(m_{CD}(\min))$	$\left(\frac{P_{C_1}}{P_{T_1}}\right)_{\min} = \cos^2(m_{R_1}(\max))J_0^2(m_{CD}(\max))$
Tele-command	$\left(\frac{P_{CD}}{P_{T_1}}\right)_{\max} = 2\cos^2(m_{R_1}(\min))J_1^2(m_{CD}(\max))$	$\left(\frac{P_{CD}}{P_{T_1}}\right)_{\min} = 2\cos^2(m_{R_1}(\max))J_1^2(m_{CD}(\min))$
Ranging	$\left(\frac{P_{R_1}}{P_{T_1}}\right)_{\max} = \sin^2(m_{R_1}(\max))J_0^2(m_{CD}(\min))$	$\left(\frac{P_{R_1}}{P_{T_1}}\right)_{\min} = \sin^2(m_{R_1}(\min))J_0^2(m_{CD}(\max))$

Earth Stations and Spacecraft

4.1.5 COMPUTATIONAL TECHNIQUE FOR THE MEAN AND VARIANCE OF THE MODULATION LOSSES FOUND IN THE CCSDS TELECOMMUNICATION LINK DESIGN CONTROL TABLE (Continued)

ANNEX TO RECOMMENDATION 4.1.5 (Continued)

TABLE 4.1.5-3b: Minima and Maxima of Uplink Modulation Losses / Sine-Wave Ranging		
Carrier	$\left(\frac{P_{C_1}}{P_{T_1}}\right)_{\max} = J_0^2(m_{R_1}(\min))J_0^2(m_{CD}(\min))$	$\left(\frac{P_{C_1}}{P_{T_1}}\right)_{\min} = J_0^2(m_{R_1}(\max))J_0^2(m_{CD}(\max))$
Tele-command	$\left(\frac{P_{CD}}{P_{T_1}}\right)_{\max} = 2J_0^2(m_{R_1}(\min))J_1^2(m_{CD}(\max))$	$\left(\frac{P_{CD}}{P_{T_1}}\right)_{\min} = 2J_0^2(m_{R_1}(\max))J_1^2(m_{CD}(\min))$
Ranging	$\left(\frac{P_{R_1}}{P_{T_1}}\right)_{\max} = 2J_1^2(m_{R_1}(\max))J_0^2(m_{CD}(\min))$	$\left(\frac{P_{R_1}}{P_{T_1}}\right)_{\min} = 2J_1^2(m_{R_1}(\min))J_0^2(m_{CD}(\max))$

4. Compute the tolerances of the modulation losses using the following formulas:

(a) Favorable Tolerance: $F_x = \frac{P_x}{P_{T_1}}(\max) - \frac{P_x}{P_{T_1}}(\text{nominal});$ and

(b) Adverse Tolerance: $A_x = \frac{P_x}{P_{T_1}}(\min) - \frac{P_x}{P_{T_1}}(\text{nominal});$

where $x = C_1, CD$ or R_1 .

5. Compute the mean and variance of the uplink modulation losses, using the PDF assigned to each modulation loss in accordance with CCSDS Recommendation 401 (4.1.4) B-1.

ALGORITHM 2 : Computation of the Mean and Variance of Downlink Modulation Losses

1. Compute the maxima and minima of downlink ranging and telemetry modulation indices by adding the favorable and adverse tolerances to the nominal values of the modulation indices.
2. Compute the minima and maxima of actual modulation indices τ_1, τ_2, τ_3 for feed through command, ranging and noise, respectively (see parameter definitions in Table 4.1.5-1b).

Note: Signal-to-noise ratios α_R, α_C depend on uplink parameters and the ranging channel's bandwidth; therefore, α_R, α_C maximization or minimization is obtained by substituting the maxima and/or minima of uplink parameters in the α_R, α_C expressions as shown in Table 4.1.5-5.

Earth Stations and Spacecraft

4.1.5 COMPUTATIONAL TECHNIQUE FOR THE MEAN AND VARIANCE OF THE MODULATION LOSSES FOUND IN THE CCSDS TELECOMMUNICATION LINK DESIGN CONTROL TABLE (Continued)

ANNEX TO RECOMMENDATION 4.1.5 (Continued)

TABLE 4.1.5-4: Maxima and Minima of Actual Downlink Modulation Indices	
$\tau_1(\text{max}) = \frac{m_{R_2}(\text{max})}{\sqrt{1 + \frac{\alpha_R(\text{min})}{\alpha_C(\text{max})} + \frac{1}{\alpha_C(\text{max})}}}$	$\tau_1(\text{min}) = \frac{m_{R_2}(\text{min})}{\sqrt{1 + \frac{\alpha_R(\text{max})}{\alpha_C(\text{min})} + \frac{1}{\alpha_C(\text{min})}}}$
$\tau_2(\text{max}) = \frac{m_{R_2}(\text{max})}{\sqrt{\frac{\alpha_C(\text{min})}{\alpha_R(\text{max})} + 1 + \frac{1}{\alpha_R(\text{max})}}}$	$\tau_2(\text{min}) = \frac{m_{R_2}(\text{min})}{\sqrt{\frac{\alpha_C(\text{max})}{\alpha_R(\text{min})} + 1 + \frac{1}{\alpha_R(\text{min})}}}$
$\tau_3(\text{max}) = \frac{m_{R_2}(\text{max})}{\sqrt{2(\alpha_C(\text{min}) + \alpha_R(\text{min}) + 1)}}$	$\tau_3(\text{min}) = \frac{m_{R_2}(\text{min})}{\sqrt{2(\alpha_C(\text{max}) + \alpha_R(\text{max}) + 1)}}$

3. Compute the nominal downlink modulation losses by substituting the nominal (design) values in the expressions in Tables 4.1.5-5a, 4.1.5-5b, and 4.1.5-5c assuming that only the first harmonic of the square wave ranging signal passes through the transponder's ranging filter or that a sinewave ranging signal is used.

TABLE 4.1.5-5a: Modulation Losses	
Downlink Carrier, Two-Channel/Square-Wave Telemetry, and Ranging	
Carrier	$\frac{P_{C_2}}{P_{T_2}} = \cos^2(m_{TM1})\cos^2(m_{TM2})J_0^2(\tau_1)J_0^2(\tau_2)e^{-\tau_3^2}$
Telemetry Channel 1	$\frac{P_{TM1}}{P_{T_2}} = \sin^2(m_{TM1})\cos^2(m_{TM2})J_0^2(\tau_1)J_0^2(\tau_2)e^{-\tau_3^2}$
Telemetry Channel 2	$\frac{P_{TM2}}{P_{T_2}} = \cos^2(m_{TM1})\sin^2(m_{TM2})J_0^2(\tau_1)J_0^2(\tau_2)e^{-\tau_3^2}$
Ranging	$\frac{P_{R_2}}{P_{T_2}} = 2\cos^2(m_{TM1})\cos^2(m_{TM2})J_0^2(\tau_1)J_1^2(\tau_2)e^{-\tau_3^2}$

Earth Stations and Spacecraft

4.1.5 COMPUTATIONAL TECHNIQUE FOR THE MEAN AND VARIANCE OF THE MODULATION LOSSES FOUND IN THE CCSDS TELECOMMUNICATION LINK DESIGN CONTROL TABLE (Continued)

ANNEX TO RECOMMENDATION 4.1.5 (Continued)

TABLE 4.1.5-5b: Modulation Losses Downlink Carrier, Two-Channel / Sine-Wave Telemetry, and Ranging	
Carrier	$\frac{P_{C_2}}{P_{T_2}} = J_0^2(m_{TM1})J_0^2(m_{TM2})J_0^2(\tau_1)J_0^2(\tau_2)e^{-\tau_3^2}$
Telemetry Channel 1	$\frac{P_{C_2}}{P_{T_2}} = 2J_1^2(m_{TM1})J_0^2(m_{TM2})J_0^2(\tau_1)J_0^2(\tau_2)e^{-\tau_3^2}$
Telemetry Channel 2	$\frac{P_{TM2}}{P_{T_2}} = 2J_0^2(m_{TM1})J_1^2(m_{TM2})J_0^2(\tau_1)J_0^2(\tau_2)e^{-\tau_3^2}$
Ranging	$\frac{P_{R_2}}{P_{T_2}} = 2J_0^2(m_{TM1})J_0^2(m_{TM2})J_0^2(\tau_1)J_1^2(\tau_2)e^{-\tau_3^2}$

TABLE 4.1.5-5c: Modulation Losses Downlink Carrier, Two-Channel / Square and Sine Wave Telemetry, and Ranging	
Carrier	$\frac{P_{C_2}}{P_{T_2}} = \cos^2(m_{TM1})J_0^2(m_{TM2})J_0^2(\tau_1)J_0^2(\tau_2)e^{-\tau_3^2}$
Telemetry Channel 1	$\frac{P_{TM1}}{P_{T_2}} = \sin^2(m_{TM1})J_0^2(m_{TM2})J_0^2(\tau_1)J_0^2(\tau_2)e^{-\tau_3^2}$
Telemetry Channel 2	$\frac{P_{TM2}}{P_{T_2}} = 2\cos^2(m_{TM1})J_1^2(m_{TM2})J_0^2(\tau_1)J_0^2(\tau_2)e^{-\tau_3^2}$
Ranging	$\frac{P_{R_2}}{P_{T_2}} = 2\cos^2(m_{TM1})J_0^2(m_{TM2})J_0^2(\tau_1)J_1^2(\tau_2)e^{-\tau_3^2}$

4. Compute lower and upper bounds of the downlink modulation loss minima and maxima by substituting the minima and maxima of modulation indices m_{TM1} , m_{TM2} , τ_1 , τ_2 , τ_3 in the expressions of Tables 4.1.5-6a, 4.1.5-6b and 4.1.5-6c. These lower and upper bounds (denoted lb and ub, respectively) of modulation loss minima and maxima as computed in Tables 4.1.5-7a, 4.1.5-7b, 4.1.5-7c differ with respect to the actual minima and maxima of the modulation losses because τ_1 , τ_2 , τ_3 are not independent variables. However, extensive computations demonstrated that the difference is always less than 0.1 dB, for the applicable ranges of modulation indices m_{TM1} , m_{TM2} , τ_1 , τ_2 , τ_3 .

Earth Stations and Spacecraft

4.1.5 COMPUTATIONAL TECHNIQUE FOR THE MEAN AND VARIANCE OF THE MODULATION LOSSES FOUND IN THE CCSDS TELECOMMUNICATION LINK DESIGN CONTROL TABLE (Continued)

ANNEX TO RECOMMENDATION 4.1.5 (Continued)

TABLE 4.1.5-6a: Downlink Modulation Loss Maxima and Minima / Square-Wave Telemetry	
Carrier	$\frac{P_{C_2}}{P_{T_2}}(ub) = \cos^2(m_{TM1}(\min))\cos^2(m_{TM2}(\min))J_0^2(\tau_1(\min))J_0^2(\tau_2(\min))e^{-\tau_3^2(\min)}$
	$\frac{P_{C_2}}{P_{T_2}}(lb) = \cos^2(m_{TM1}(\max))\cos^2(m_{TM2}(\max))J_0^2(\tau_1(\max))J_0^2(\tau_2(\max))e^{-\tau_3^2(\max)}$
Telemetry i, j=1, 2 i≠j	$\frac{P_{TMi}}{P_{T_2}}(ub) = \sin^2(m_{TMi}(\max))\cos^2(m_{TMj}(\min))J_0^2(\tau_1(\min))J_0^2(\tau_2(\min))e^{-\tau_3^2(\min)}$
	$\frac{P_{TMi}}{P_{T_2}}(lb) = \sin^2(m_{TMi}(\min))\cos^2(m_{TMj}(\max))J_0^2(\tau_1(\max))J_0^2(\tau_2(\max))e^{-\tau_3^2(\max)}$
Ranging	$\frac{P_{R_2}}{P_{T_2}}(ub) = 2\cos^2(m_{TM1}(\min))\cos^2(m_{TM2}(\min))J_0^2(\tau_1(\min))J_1^2(\tau_2(\max))e^{-\tau_3^2(\min)}$
	$\frac{P_{R_2}}{P_{T_2}}(lb) = 2\cos^2(m_{TM1}(\max))\cos^2(m_{TM2}(\max))J_0^2(\tau_1(\max))J_1^2(\tau_2(\min))e^{-\tau_3^2(\max)}$

TABLE 4.1.5-6b: Downlink Modulation Loss Maxima and Minima / Sine-Wave Telemetry	
Carrier	$\frac{P_{C_2}}{P_{T_2}}(ub) = J_0^2(m_{TM1}(\min))J_0^2(m_{TM2}(\min))J_0^2(\tau_1(\min))J_0^2(\tau_2(\min))e^{-\tau_3^2(\min)}$
	$\frac{P_{C_2}}{P_{T_2}}(lb) = J_0^2(m_{TM1}(\max))J_0^2(m_{TM2}(\max))J_0^2(\tau_1(\max))J_0^2(\tau_2(\max))e^{-\tau_3^2(\max)}$
Telemetry i, j=1, 2 i≠j	$\frac{P_{TMi}}{P_{T_2}}(ub) = 2J_1^2(m_{TMi}(\max))J_0^2(m_{TMj}(\min))J_0^2(\tau_1(\min))J_0^2(\tau_2(\min))e^{-\tau_3^2(\min)}$
	$\frac{P_{TMi}}{P_{T_2}}(lb) = 2J_1^2(m_{TMi}(\min))J_0^2(m_{TMj}(\max))J_0^2(\tau_1(\max))J_0^2(\tau_2(\max))e^{-\tau_3^2(\max)}$
Ranging	$\frac{P_{R_2}}{P_{T_2}}(ub) = 2J_0^2(m_{TM1}(\min))J_0^2(m_{TM2}(\min))J_0^2(\tau_1(\min))J_1^2(\tau_2(\max))e^{-\tau_3^2(\min)}$
	$\frac{P_{R_2}}{P_{T_2}}(lb) = 2J_0^2(m_{TM1}(\max))J_0^2(m_{TM2}(\max))J_0^2(\tau_1(\max))J_1^2(\tau_2(\min))e^{-\tau_3^2(\max)}$

Earth Stations and Spacecraft

4.1.5 COMPUTATIONAL TECHNIQUE FOR THE MEAN AND VARIANCE OF THE MODULATION LOSSES FOUND IN THE CCSDS TELECOMMUNICATION LINK DESIGN CONTROL TABLE (Continued)

ANNEX TO RECOMMENDATION 4.1.5 (Continued)

TABLE 4.1.5-6c: Downlink Modulation Loss Maxima and Minima / Square and Sine Wave Telemetry	
Carrier	$\frac{P_{C_2}}{P_{T_2}}(ub) = \cos^2(m_{TM1}(\min))J_0^2(m_{TM2}(\min))J_0^2(\tau_1(\min))J_0^2(\tau_2(\min))e^{-\tau_3^2(\min)}$
	$\frac{P_{C_2}}{P_{T_2}}(lb) = \cos^2(m_{TM1}(\max))J_0^2(m_{TM2}(\max))J_0^2(\tau_1(\max))J_0^2(\tau_2(\max))e^{-\tau_3^2(\max)}$
Telemetry Channel 1 Square Wave	$\frac{P_{TM1}}{P_{T_2}}(ub) = \sin^2(m_{TM1}(\max))J_0^2(m_{TM2}(\min))J_0^2(\tau_1(\min))J_0^2(\tau_2(\min))e^{-\tau_3^2(\min)}$
	$\frac{P_{TM1}}{P_{T_2}}(lb) = \sin^2(m_{TM1}(\min))J_0^2(m_{TM2}(\max))J_0^2(\tau_1(\max))J_0^2(\tau_2(\max))e^{-\tau_3^2(\max)}$
Telemetry Channel 2 Sine Wave	$\frac{P_{TM2}}{P_{T_2}}(ub) = 2\cos^2(m_{TM1}(\min))J_1^2(m_{TM2}(\max))J_0^2(\tau_1(\min))J_0^2(\tau_2(\min))e^{-\tau_3^2(\min)}$
	$\frac{P_{TM2}}{P_{T_2}}(lb) = 2\cos^2(m_{TM1}(\max))J_1^2(m_{TM2}(\min))J_0^2(\tau_1(\max))J_0^2(\tau_2(\max))e^{-\tau_3^2(\max)}$
Ranging	$\frac{P_{R_2}}{P_{T_2}}(ub) = 2\cos^2(m_{TM1}(\min))J_0^2(m_{TM2}(\min))J_0^2(\tau_1(\min))J_1^2(\tau_2(\max))e^{-\tau_3^2(\min)}$
	$\frac{P_{R_2}}{P_{T_2}}(lb) = 2\cos^2(m_{TM1}(\max))J_0^2(m_{TM2}(\max))J_0^2(\tau_1(\max))J_1^2(\tau_2(\min))e^{-\tau_3^2(\max)}$

5. Compute the tolerances of downlink modulation losses, using formulas as in Algorithm 1 Part 4 with $x = C_2, TM1, TM2,$ and R_2 .
6. Compute the mean and variance of the downlink modulation losses, using the PDF assigned to each modulation loss.

Earth Stations and Spacecraft

4.1.5 COMPUTATIONAL TECHNIQUE FOR THE MEAN AND VARIANCE OF THE MODULATION LOSSES FOUND IN THE CCSDS TELECOMMUNICATION LINK DESIGN CONTROL TABLE (Continued)

ANNEX TO RECOMMENDATION 4.1.5 (Continued)

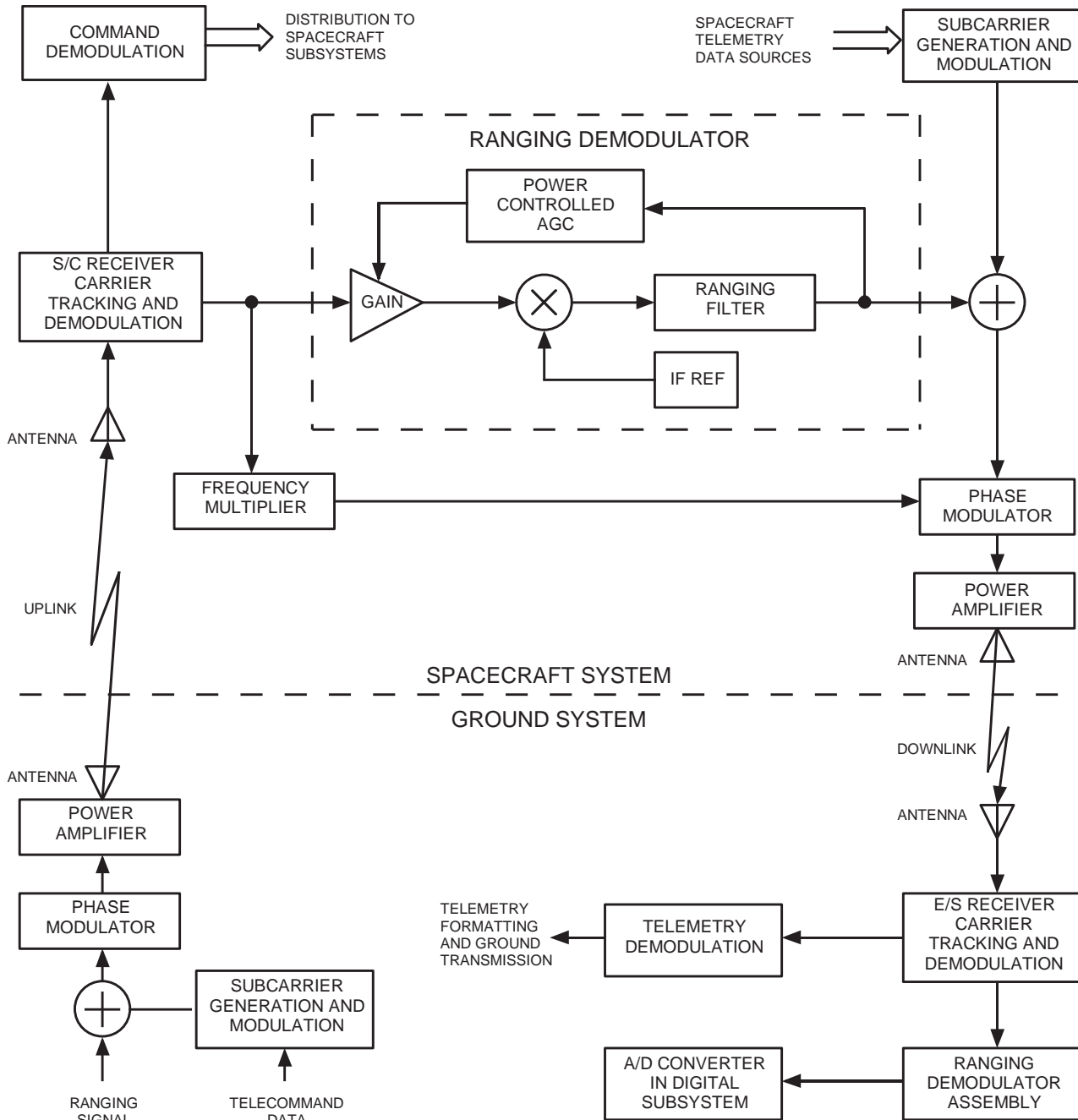
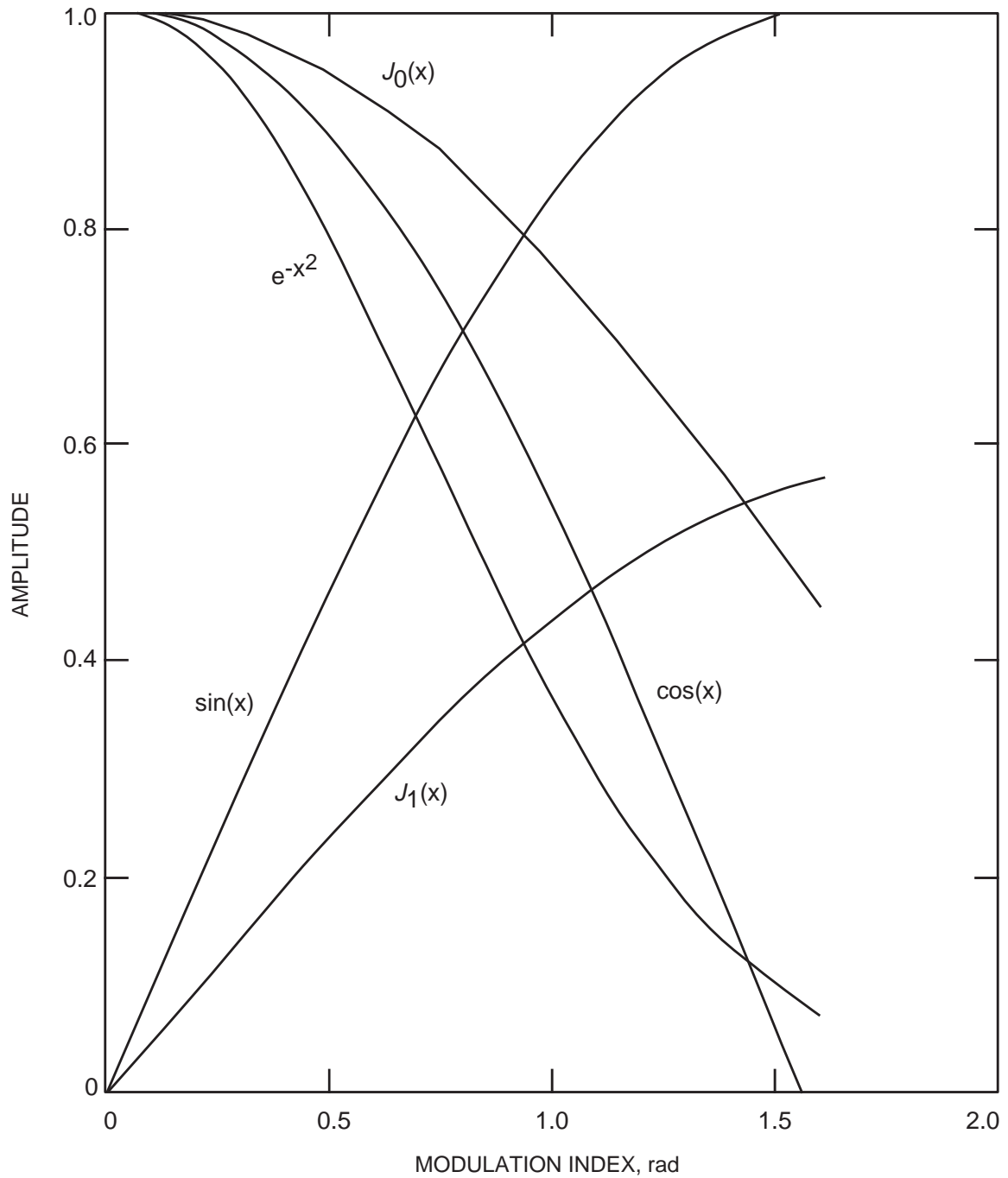

Figure 4.1.5-1: Simplified Block Diagram for Two-Way Simultaneous Telecommand/Ranging and Telemetry/Ranging Operations

Earth Stations and Spacecraft

4.1.5 COMPUTATIONAL TECHNIQUE FOR THE MEAN AND VARIANCE OF THE MODULATION LOSSES FOUND IN THE CCSDS TELECOMMUNICATION LINK DESIGN CONTROL TABLE (Continued)

ANNEX TO RECOMMENDATION 4.1.5 (Continued)



6445-446ab

Figure 4.1.5-2: Bessel, Trigonometric, and Exponential Curves for 0 to $\pi/2$ Radians

Earth Stations and Spacecraft

4.2.1 COMPUTATIONAL METHOD FOR DETERMINING THE OCCUPIED BANDWIDTH OF UNFILTERED PCM/PM SIGNALS

The CCSDS,

considering

- (a) that the occupied bandwidth is defined as that band of frequencies which contain 99% of the total radiated power (ITU-RR-1.153);
- (b) that the occupied bandwidth of unfiltered modulated signals provides a useful indication as to whether filtering may be necessary to optimally use the allocated frequency band;
- (c) that a simple, closed-form expression for calculating the occupied bandwidth of PCM/PM signals, using either NRZ or Bi-Phase formats, is not available;
- (d) that approximations for computing occupied bandwidth of PCM/PM signals, having an accuracy of better than 90% over the specified ranges of modulation indices, have been developed and are compared with theoretical values in figure 4.2.1-1;

recommends

that the occupied bandwidth of PCM/PM signals containing 99% of the total radiated power can be calculated, with an accuracy of better than 90%, using the following approximations:

$$BW = 2 \times (26.2m - 5.16)R_s \quad \text{for Bi-Phase}^1 \text{ format: } (0.4 \text{ rad} \leq m \leq 1.4 \text{ rad});$$

$$BW = 2 \times (8.93m - 1.75)R_s \quad \text{for NRZ format: } (0.4 \text{ rad} \leq m \leq 1.4 \text{ rad}).$$

NOTES:

- BW = Occupied Bandwidth is the band of frequencies containing 99% of the total radiated power,
- R_s = Modulated Symbol Rate,
- m = Modulation Index (in radians).

¹ For the purpose of this recommendation, the symbol rates are defined prior to Bi-phase encoding.

Earth Stations and Spacecraft

4.2.1 COMPUTATIONAL METHOD FOR DETERMINING THE OCCUPIED BANDWIDTH OF UNFILTERED PCM/PM SIGNALS (Continued)

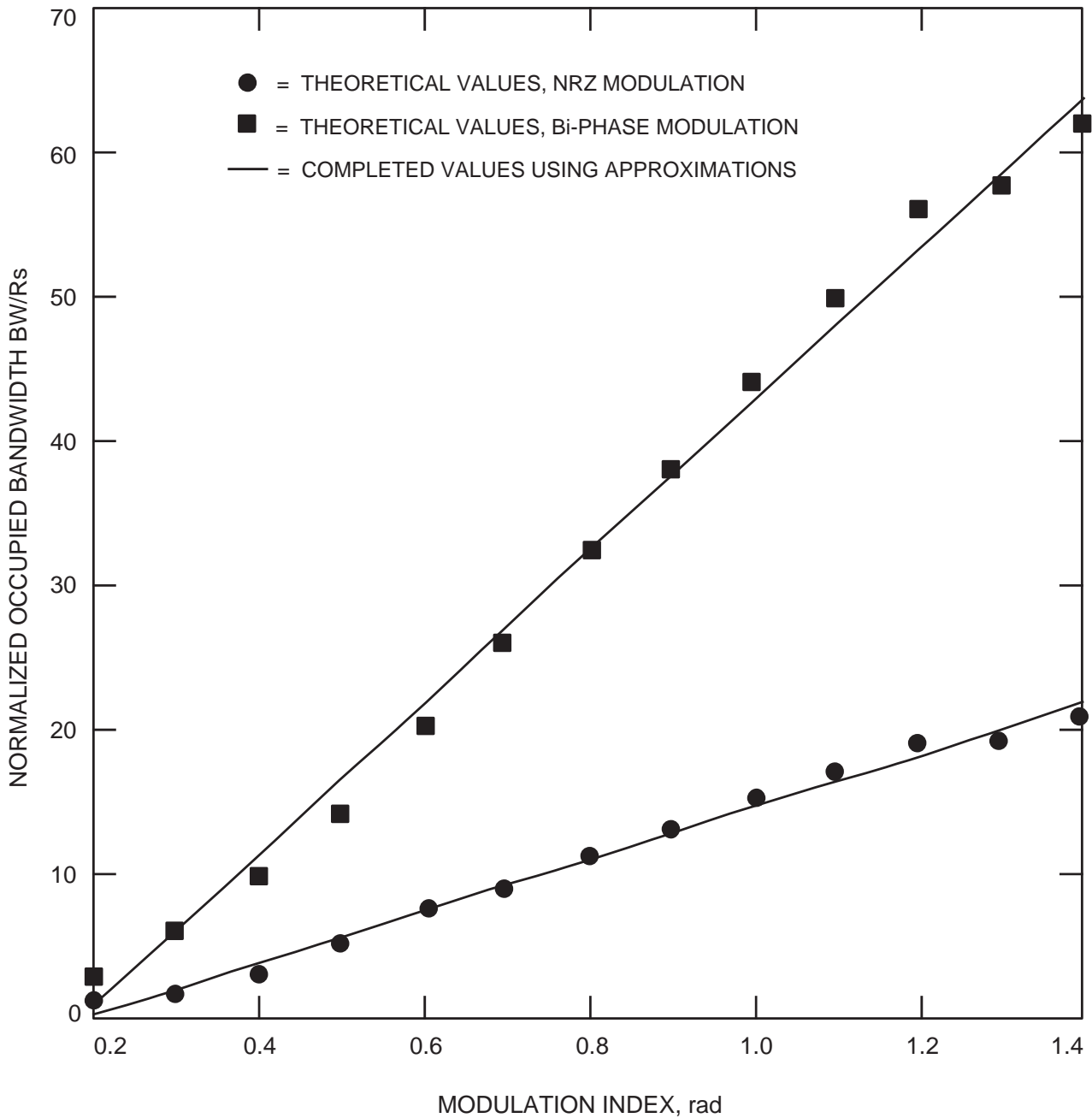

6445-444ab

Figure 4.2.1-1: Comparison of Theoretical and Computed Approximate Values for Occupied Bandwidth

Earth Stations and Spacecraft

4.2.2 COMPUTATIONAL METHOD FOR DETERMINING THE OCCUPIED BANDWIDTH OF UNFILTERED PCM/PSK/PM MODULATION WITH A SINEWAVE SUBCARRIER

The CCSDS,

considering

- (a) that prior to the design of spacecraft and the assignment of frequencies, the *Occupied Bandwidth* must be known;
- (b) that the *Occupied Bandwidth* is defined as the frequency band containing 99% of the emitted power (ITU-RR-1.153);
- (c) that for PCM/PSK/PM modulation with an NRZ data format, a simple, exact closed form expression to calculate the *Occupied Bandwidth* is not available over the full range of applicable modulation indices;
- (d) that an approximation having better than 10% accuracy has been developed for a representative range of modulation indices;
- (e) that the *Occupied Bandwidth* can be computed with high precision using numerical integration techniques and can be plotted for easy use;

recommends

- (1) that the *Occupied Bandwidth*, B , for PCM/PSK/PM with a sinewave subcarrier be estimated by:

$$B = 4n \cdot R_s \text{ for } 0.8 < m < 1.35 \text{ and } n > 7 \text{ (in Hz)}$$

where:

n	=	subcarrier frequency-to-symbol rate ratio
R_s	=	symbol rate (s/s)
m	=	modulation index (radians peak);

- (2) that B for any other combination of m and n be determined by using figure 4.2.2-1.

Earth Stations and Spacecraft

4.2.2 COMPUTATIONAL METHOD FOR DETERMINING THE OCCUPIED BANDWIDTH OF UNFILTERED PCM/PSK/PM MODULATION WITH A SINEWAVE SUBCARRIER (Continued)

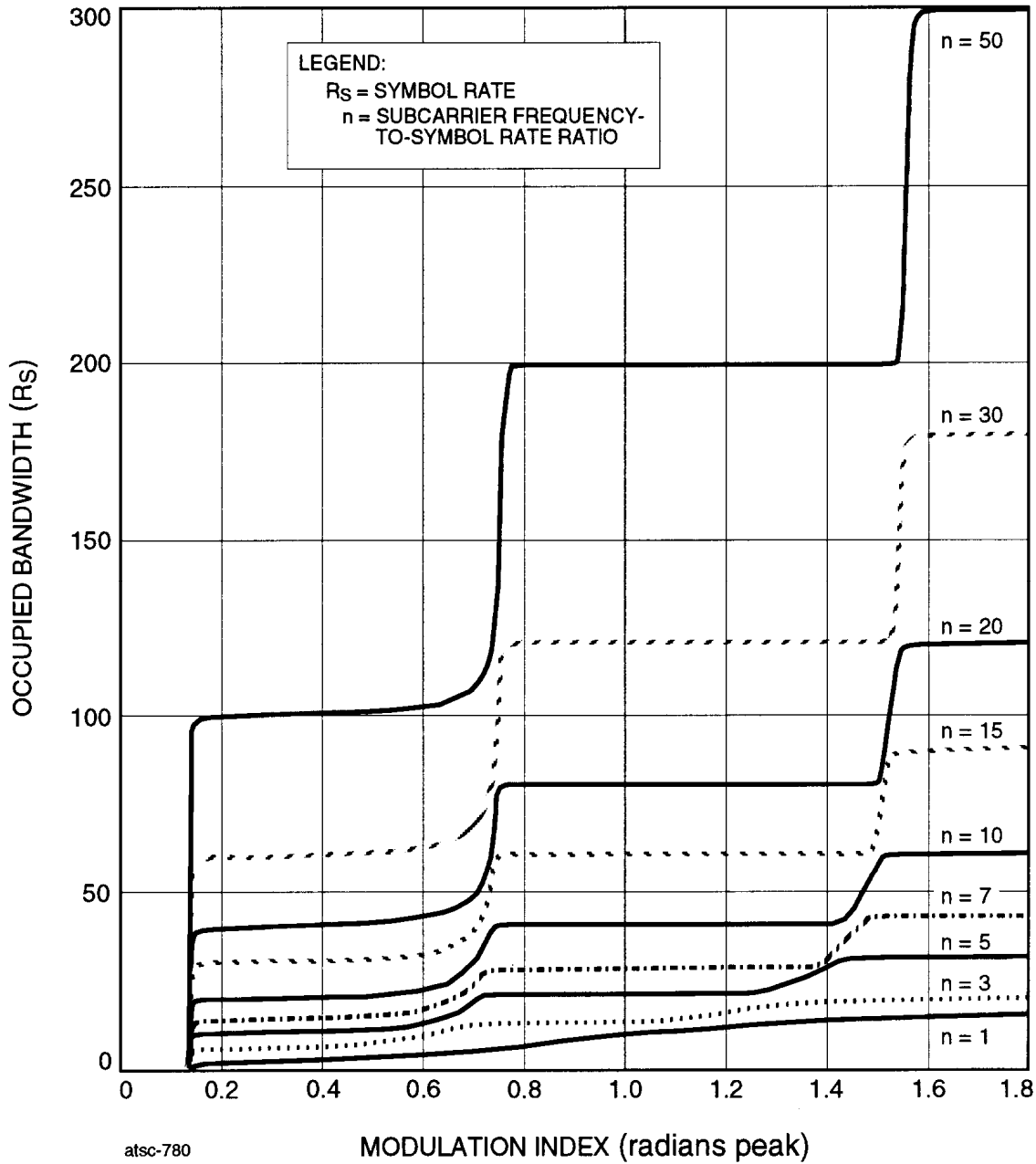

Figure 4.2.2-1: Occupied Bandwidth of Unfiltered PCM/PSK/PM Signal with a Sinewave Subcarrier

Earth Stations and Spacecraft

4.2.3 COMPUTATIONAL METHOD FOR DETERMINING THE OCCUPIED BANDWIDTH OF UNFILTERED PCM/PSK/PM MODULATION WITH A SQUAREWAVE SUBCARRIER

The CCSDS,

considering

- (a) that prior to the design of spacecraft and the assignment of frequencies, the *Occupied Bandwidth* must be known;
- (b) that the *Occupied Bandwidth* is defined as the frequency band containing 99% of the emitted power (ITU-RR-1.153);
- (c) that for PCM/PSK/PM modulation with an NRZ data format, a simple, exact closed form expression to calculate the *Occupied Bandwidth* is not available over the full range of applicable modulation indices;
- (d) that an approximation having better than 10% accuracy has been developed for a representative range of modulation indices;
- (e) that the *Occupied Bandwidth* can be computed with high precision using numerical integration techniques and can be plotted for easy use;

recommends

- (1) that the *Occupied Bandwidth*, B, for PCM/PSK/PM with a squarewave subcarrier be estimated by:

$$B = [(- 43.2 m^3 + 103 m^2 - 2 m - 1) n + 11] \bullet R_s \quad \text{for } m > 0.5 \text{ radians (in Hz)}$$

where:

n	=	subcarrier frequency-to-symbol rate ratio
R _s	=	symbol rate (s/s)
m	=	modulation index (radians peak);

- (2) that B for any other combination of m and n be determined by using figure 4.2.3-1.

Earth Stations and Spacecraft

4.2.3 COMPUTATIONAL METHOD FOR DETERMINING THE OCCUPIED BANDWIDTH OF UNFILTERED PCM/PSK/PM MODULATION WITH A SQUAREWAVE SUBCARRIER (Continued)

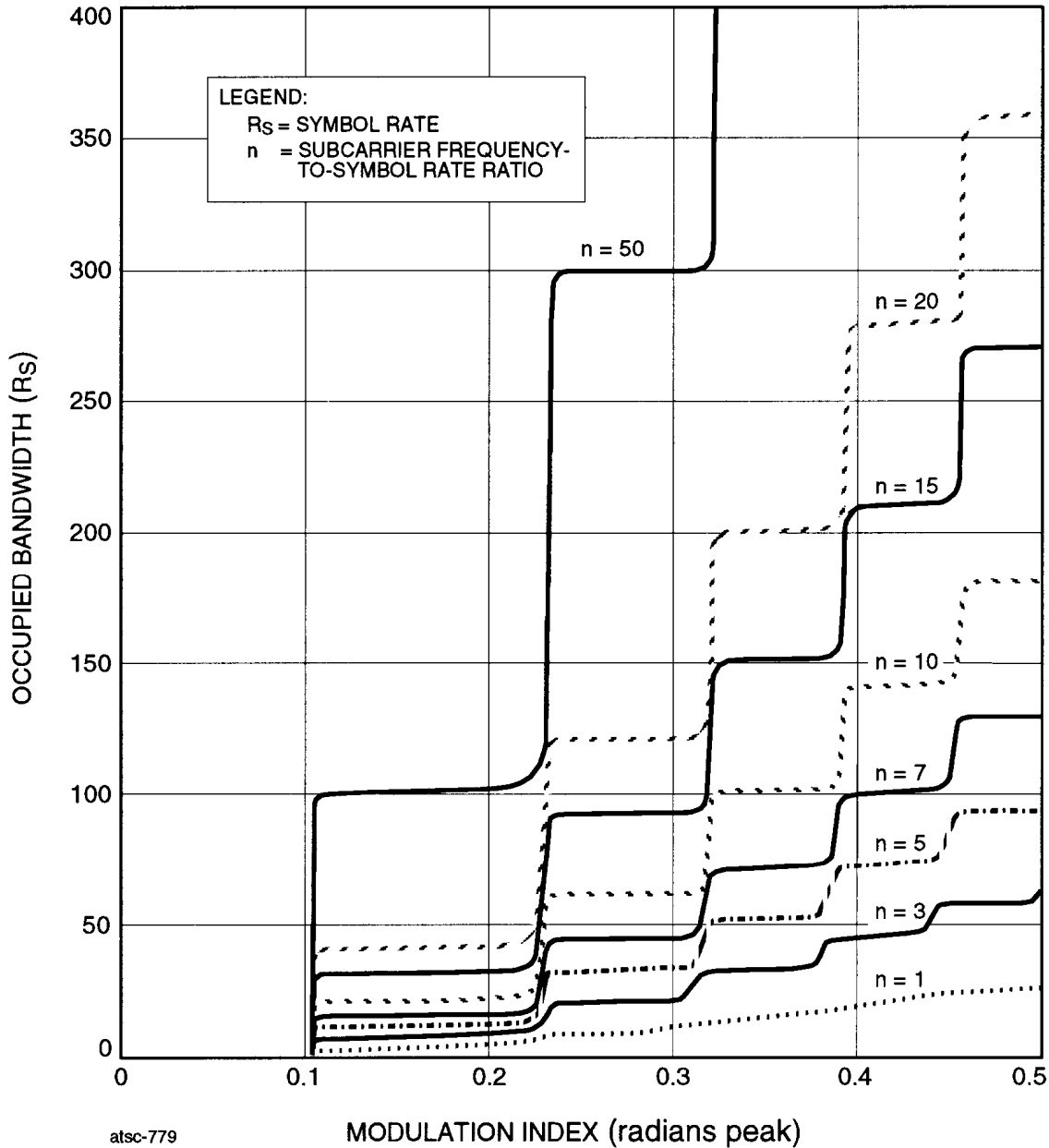

Figure 4.2.3-1: Occupied Bandwidth of Unfiltered PCM/PSK/PM Signal with a Squarewave Subcarrier

Earth Stations and Spacecraft

5.0 TERMINOLOGY AND GLOSSARY

Section 5 is included to assist the reader in interpreting the Recommendations found in Sections 2, 3, and 4 of this document. It does so by providing an explanation of key words, terms, phrases, abbreviations, and acronyms used in these Recommendations. Presently, there are two subsections:

5.1 *Terminology*

5.2 *Glossary*

Section 5.1, Terminology, defines specific words, terms, and phrases which have special, but uniform, meanings throughout the text. Additionally, this section also includes quantitative values for some terms which are intended to assist the reader in interpreting the Recommendations.

Section 5.2, Glossary, contains the full name for the abbreviations and acronyms used throughout this document. If a reader is uncertain as to the meaning any abbreviation or acronym, this Section should be consulted. Here, entries are arranged alphabetically.

Earth Stations and Spacecraft

5.1 TERMINOLOGY

<i>Autotrack</i>	A system which causes Earth station's antenna to automatically follow [track] a moving spacecraft.
<i>Bit Rate</i>	The baseband data rate exclusive of coding for either error correction or spectrum shaping purposes.
<i>Category A Missions</i>	Those missions whose altitude above the Earth is less than 2×10^6 km.
<i>Category B Missions</i>	Those missions whose altitude above the Earth is greater than, or equal to, 2×10^6 km.
<i>Loop Bandwidth</i>	The resultant phase locked bandwidth when the signal-to-noise ratio in the phase locked loop is 10 dB.
<i>Loop Threshold</i>	That signal level producing a signal-to-noise ratio of 10 dB in the phase locked loop's bandwidth.
<i>Libration Point</i>	A point of equal potential gravitational fields between two or more large bodies such as the sun and the Earth.
<i>Link Design Control Table</i>	A set of tables used to display the operating parameters of a telecommunications link and to calculate the expected performance of that link.
<i>Link and Weather Not Combined</i>	With a Link Design Control Table, calculations are made assuming clear and dry weather conditions. Thereafter, the values obtained under such ideal conditions are adjusted using a correction factor representing the loss due to weather effects.
<i>Modulo-2 Addition</i>	Also called an <i>exclusive or</i> , this term refers to the manner in which a pair of bits are added such that like bits result in a 0 and unlike bits produce a 1.
<i>Occupied Bandwidth</i>	(ITU-RR-1.153): "The width of a frequency band such that, below the lower and above the upper frequency limits, the mean powers emitted are each equal to a specified percentage $\beta/2$ of the total mean power of a given emission." [Unless otherwise specified by the CCIR for the appropriate class of emission, the value of $\beta/2$ should be taken as 0.5%.]

Earth Stations and Spacecraft

5.1 TERMINOLOGY (Continued)

<i>Radiocommunication Service</i>	(ITU-RR-1.19) “A Service . . . involving the transmission, emission and/or reception of radio waves for specific telecommunication purposes.”
<i>Ranging Measurement</i>	A process for establishing, usually by a time delay measurement, the one-way distance between an Earth station and a spacecraft.
<i>Symbol Rate</i>	The baseband bit rate following error correction coding excluding spectrum modification encoding like Trellis encoding but including Bi-phase encoding unless a note to the contrary is present in the recommendation under consideration.

Earth Stations and Spacecraft

5.2 GLOSSARY OF TERMS

ACQ or Acq	Acquisition
AGC	Automatic Gain Control
AM	Amplitude Modulation
BER	Bit Error Rate
Bi- ϕ -L	Bi-Phase-Level modulation
Bi- ϕ -M	Bi-Phase-Mark modulation
Bi- ϕ -S	Bi-Phase-Space modulation
B _{LO}	Phase Locked Loop Bandwidth
BNSC	British National Space Centre
bps or b/s	Bits Per Second
BW	Bandwidth
Cat	Category
Category A Missions	Those missions whose altitude above the Earth is less than, or equal to, 2×10^6 km
Category B Missions	Those missions whose altitude above the Earth is greater than 2×10^6 km
CCIR	International Radio Consultative Committee
CCSDS	Consultative Committee for Space Data Systems
Cmd	Telecommand
CNES	Centre National D'Etudes Spatiales
COHER or Coh	Coherent
CRC	Communications Research Centre
CRL	Communications Research Laboratory
CSA	Canadian Space Agency
dB	Decibel(s)
dB _i	Decibel(s) relative to an isotropically radiated signal
dB/K	Decibel(s) per degree Kelvin
dB _m	Decibel(s) relative to one milliwatt
dBW	Decibel(s) relative to one Watt
DCT	Design Control Table [Link]
deg	Degree
DLR	Deutsches Zentrum für Luft- und Raumfahrt e.V.

Earth Stations and Spacecraft

5.2 GLOSSARY OF TERMS (Continued)

DNRZ	Differential Non-Return to Zero
DRVID	Differenced Range vs. Integrated Doppler
E_b	Energy per data bit
E_b/N_o	Energy per data bit to Noise ratio in a 1 Hz bandwidth
EES	Earth Exploration Service
EIRP	Equivalent Isotropically Radiated Power
ELEV	Elevation
E/S	Earth-to-Space
ESA	European Space Agency
exp	Exponent
f or Freq	Frequency
f_c	RF carrier frequency
f_d	Doppler frequency shift
f_{sc}	Subcarrier frequency
FM	Frequency Modulation
FN or Fn	Footnote
FSK	Frequency Shift Keying
GHz	Gigahertz
GND	Ground
GPS	Global Positioning System
G/T	Antenna gain divided by the receiving system's noise temperature in degrees Kelvin (usually expressed in dB)
h	Hours
Hz	Hertz
IEEE	Institute of Electrical and Electronic Engineers
IFRB	International Frequency Registration Board
INPE	Instituto De Pesquisas Espaciais
ISAS	Institute of Space and Astronautical Science
ISRO	Indian Space Research Organization
ITU	International Telecommunication Union
ITU/RR	International Telecommunication Union Radio Regulations
k	Kilo (thousands)

Earth Stations and Spacecraft

5.2 GLOSSARY OF TERMS (Continued)

K	Degrees Kelvin
kb/s	Kilobits Per Second
kHz	Kilohertz
km	Kilometers
Ku	Ku-band (approximately 13 to 15 gigahertz)
LCP	Left Circular Polarization
LIM or Lim	Limitation(s)
LIN or Lin	Linear
L.O. or LO	Local Oscillator
M	Mega (million)
m	Meter(s)
MAX or Max	Maximum
MHz	Megahertz
MIN or Min	Minimum
Mod	Modulation
n	Nano
ns	Nanosecond(s)
NASA	National Aeronautics and Space Administration
NASDA	National Space Development Agency of Japan
NOAA	National Oceanic and Atmospheric Administration
NRZ	Non-Return to Zero
NRZ-L	Non-Return to Zero-Level
NRZ-M	Non-Return to Zero-Mark
NRZ-S	Non-Return to Zero-Space
P_c	Carrier power
PCM	Pulse Code Modulation
PDF	Probability Density Function
PFD	Power Flux Density
Pk or pk	Peak
P_{LL}	Phase Locked Loop
PM	Phase Modulation

Earth Stations and Spacecraft

5.2 GLOSSARY OF TERMS (Continued)

PN	Pseudo Noise
ppm	Parts Per Million
PRN	Pseudo Random Noise
PSK	Phase Shift Keying
PWR	Power
QPSK	Quadra-Phase Shift Keying [modulation]
OQPSK	Offset Quadra-Phase Shift Keying [modulation]
r	Range
Rad	Radian
RCP	Right Circular Polarization
RCVR or Rcvr	Receiver
Rec	Receive
REF or Ref	Reference
regen.	regenerative
resid.	residual
RF	Radio Frequency
RFI	Radio Frequency Interference
RLIN	Rotatable Linear polarization
rms	Root Mean Square
Rng	Ranging
RSS	Root Sum Square
S/C	Spacecraft
s or sec	Second(s)
S/E	Space-to-Earth
SEP	Sun-Earth-Probe [angle]
seq	Sequential
SFDU	Standard Formatted Data Unit (CCSDS)
SFCG	Space Frequency Coordination Group
SIG or sig	Signal
Sim	Simultaneous
SNR	Signal-to-Noise Ratio

Earth Stations and Spacecraft

5.2 GLOSSARY OF TERMS (Continued)

SP	Split Phase
SP-L	Split Phase - Level
sps or s/s	Symbols Per Second
SSC	Swedish Space Corporation
STA	Station
STAB	Stability
SUBCARR	Subcarrier
SYM or sym	Symbol
TBD	To Be Determined
TDRSS	Tracking and Data Relay Satellite System
Tlm	Telemetry
Trans or Tr	Transmit
TTC	Tracking, Telemetry, and Command
UTC	Universal Time Coordinated
VLBI	Very Long Baseline Interferometry
w/m ²	Watts per square Meter
X-band	Approximately 8000 megahertz
XMIT or Xmit	Transmit
yr	Year
Δ	Delta (change or variation)
ϕ	Phase
μ	Micro